

GenStar^{MPPT™}

Solar DC System Controller

Installation, Operation and Maintenance Manual

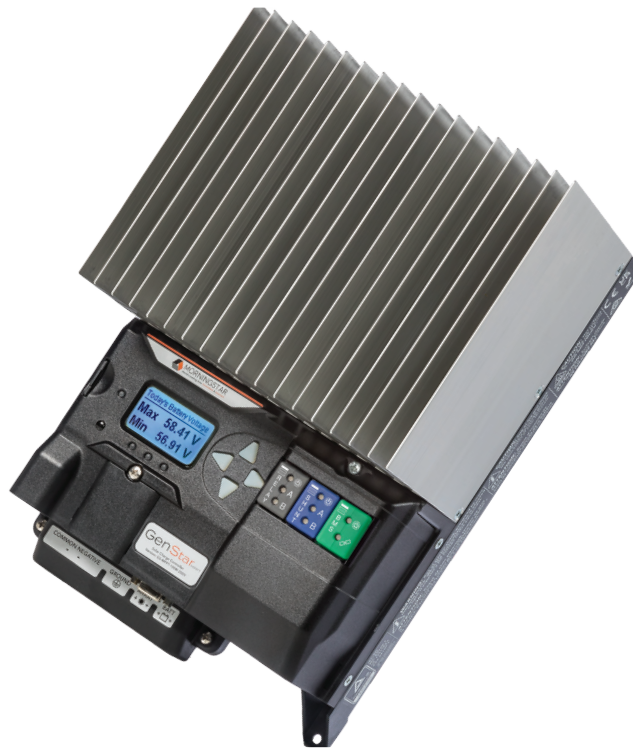

Solar Battery Charger & Load Controller
With
TrakStar™ Maximum Power Point Tracking Technology



MODELS

GS-MPPT-60M-200V
GS-MPPT-80M-200V
GS-MPPT-100M-200V



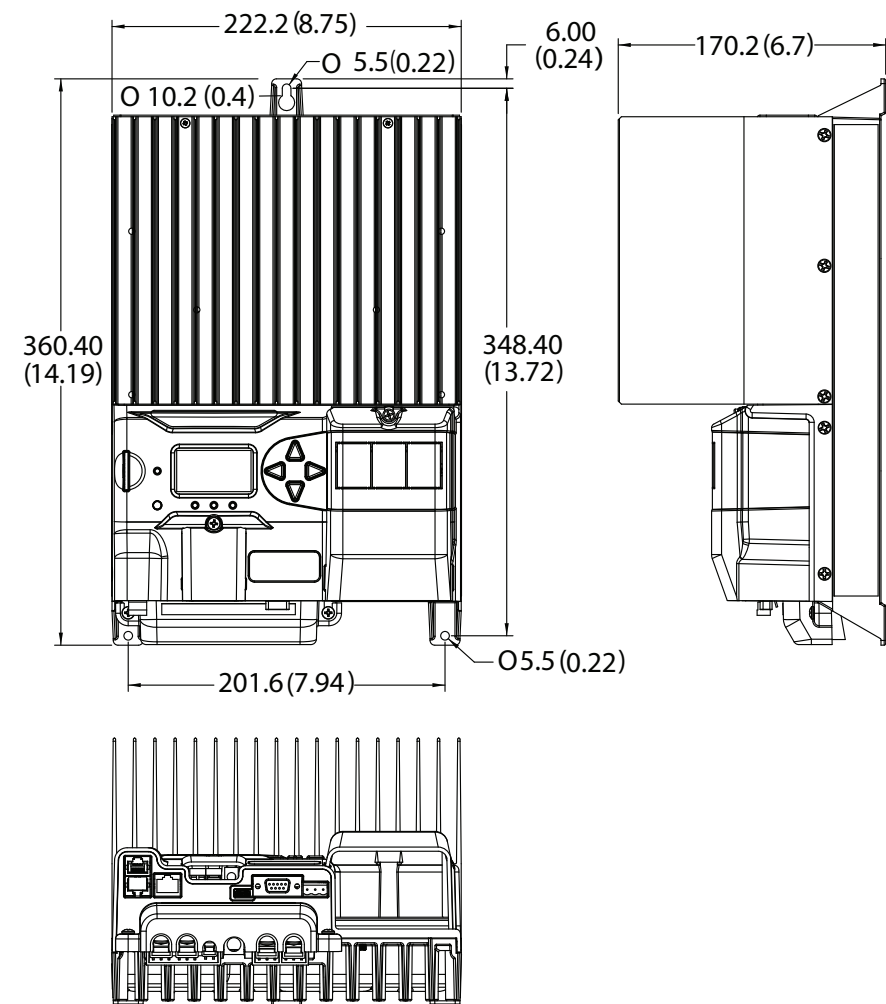

SPECIFICATION SUMMARY

	GS-MPPT-60	GS-MPPT-80	GS-MPPT-100
Nominal Battery Voltage	12-24-48V	12-24-48V	12-24-48V
Maximum PV Open-circuit Voltage ¹	200V	200V	200V
Nominal Maximum Output Power	800-1600-3200W	1075-2150-4300W	1350-2700-5400W
Maximum Recommended PV Input Power ²	1200-2400-4800W	1600-3200-6400W	2000-4000-8000W
Maximum Charging Current ³	60A	80A	100A
Rated Load Current	30A	30A	30A

¹ Array voltage should never exceed this limit

² 150% of Nominal Maximum Output Power

³ Maximum includes battery current plus any load current

TABLE OF CONTENTS

1.0 Important Safety Instructions.....1

1.1 Tools Required.....3

2.0 General Information.... 4

2.1 Overview.....4

2.2 Versions and Ratings..... 4

2.3 Exterior Features.....5

2.4 Interior Features.....7

2.5 Optional Accessories.....9

3.0 Installation.....10

3.1 General Installation Notes..... 10

3.2 Mounting.....11

3.3 Over-current Protection Devices and Disconnect Switches.....13

3.4 Wiring.....15

3.4.1 Battery Sense Wires.....16

3.4.2 Remote Temperature Sensor with Ferrite Choke.....18

3.4.3 Grounding and Ground-fault Interruption.....19

3.4.4 Battery Connections.....20

3.4.5 Solar Connections.....21

3.4.6 Load Connections.....22

3.4.7 Ready Block Installation.....22

3.4.8 Final Connections.....24

3.4.9 Power Up and Verify System Operation.....24

3.4.10 Power Down.....25

3.5 Commissioning / Initial Configuration.....25

3.5.1 Methodology.....25

3.5.2 Commissioning Menu.....25

3.5.3 Stand-alone Commissioning Settings.....25

(Cont.)

4.0 Configuration.....	28
4.1 Adjusting Settings.....	28
4.1.1 Using the Meter Display.....	28
4.1.2 Using the Mobile App.....	29
4.1.3 Using LiveView UI.....	30
4.1.4 LiveView Screen.....	30
4.1.5 Settings Screen.....	30
4.2 Setup and Installer Setup.....	31
4.2.1 Date and Time.....	31
4.2.2 Network Settings.....	32
4.2.3 SD Card and Logged Data Storage.....	32
4.2.4 Load Control (Installer Setup).....	33
4.2.5 Charger (Installer Setup).....	34
4.2.6 Schedules.....	36
4.2.7 ReadyBlocks™ and ReadyShunt State-of-charge Measurements (Installer Setup).....	36
4.2.8 External Source Control (Installer Setup).....	39
4.2.9 Local Meter Display and Button.....	44
4.2.10 Save and Load.....	44
5.0 Operation.....	45
5.1 TrakStar MPPT Technology.....	45
5.2 GenStar MPPT Charging.....	46
5.2.1 Charging Algorithms.....	46
5.2.2 Charging Profiles.....	47
5.2.3 Bulk Charging Stage.....	49
5.2.4 Absorption Stage.....	49
5.2.5 Float Stage.....	49
5.2.6 Equalization Stage.....	49
5.2.7 Charging Variables.....	51
5.3 Load Control Information.....	54
5.4 Soft-key Use.....	55

(Cont.)

5.5 Factory Reset Procedure.....	55
5.6 LED Indications.....	55
5.6.1 General LED Indications.....	55
5.6.2 Battery Charging LED Indications.....	56
5.6.3 Battery State-of-Charge (SOC) LED Indications.....	56
5.6.4 Ethernet Jack Indications.....	58
5.7 Alarms and Faults.....	58
5.7.1 Alarms.....	58
5.7.2 Faults.....	60
5.8 LiveView Menus.....	61
5.9 Commands.....	62
5.9.1 Toggle Load Terminal Output.....	62
5.9.2 Counters.....	62
5.9.3 Toggle Battery Charger.....	62
5.9.4 System Commands.....	62
5.9.5 External Source Control (ESC) Commands.....	63
5.9.6 ReadyRelays.....	63
5.10 History.....	63
5.10.1 Daily Records.....	63
5.10.2 Event Logging.....	64
5.11 Setup.....	64
5.12 Firmware Updates.....	64
5.12.1 Update via SD Card.....	65
5.13 Inspection and Maintenance.....	65
6.0 Networking and Communications.....	67
6.1 Introduction.....	67
6.2 Morningstar MS-CAN (MS-CAN functionality is not available with this release.).....	67
6.3 Serial RS-232.....	68
6.4 Modbus and ModbusIP via EIA-485.....	69
6.5 Ethernet.....	70
6.6 Simple Network Management Protocol (SNMP).....	70
6.6.1 SNMP Troubleshooting.....	72
6.7 Network Information.....	72
6.8 Accessing LiveView Web pages.....	73

(Cont.)

7.0 Troubleshooting.....74
 7.1 LED Fault Indications..... 74
 7.2 Battery Charging and Performance Issues.....76

8.0 Warranty and Policies.....77

9.0 Technical specifications.....79

Appendix - Wire Sizing Information.....87

Certifications..... 91

1.0 IMPORTANT SAFETY INSTRUCTIONS

SAVE THESE INSTRUCTIONS.

This manual contains important safety, installation, operating and maintenance instructions for the GS-MPPT-60M-200V, GS-MPPT-80M-200V, GS-MPPT-100M-200V. For safety purposes, these instructions must be followed during installation, operation and maintenance of the GenStar MPPT solar controller.

The following symbols are used throughout this manual to indicate potentially dangerous conditions or mark important safety instructions:

 **WARNING:** Indicates a potentially dangerous condition. Use extreme caution when performing this task.

 **CAUTION:** Indicates a critical procedure for safe and proper operation of the controller.

 **NOTE:** Indicates a procedure or function that is important to the safe and proper operation of the controller.

Safety Information

- Read all of the instructions and cautions in the manual before beginning installation.
- There are no user serviceable parts inside the GenStar MPPT. Do not disassemble or attempt to repair the controller.

 **WARNING: Risk Of Electrical Shock.**
NO POWER OR ACCESSORY TERMINALS ARE ELECTRICALLY ISOLATED FROM DC INPUT, AND MAY BE ENERGIZED WITH HAZARDOUS SOLAR VOLTAGE. UNDER CERTAIN FAULT CONDITIONS, BATTERY COULD BECOME OVER-CHARGED. TEST BETWEEN ALL TERMINALS AND GROUND BEFORE TOUCHING.

- External solar and battery disconnects are required.
- Disconnect all sources of power to the controller before installing or adjusting the GenStar MPPT.
- There are no fuses or disconnects inside the GenStar MPPT Do not attempt to repair.

Installation Safety Precautions

 **WARNING: Shock Hazard**
 This unit is not provided with a GFDI device. This charge controller must be used with an external GFDI device as required by the Article 690 of the National Electrical Code for the installation location.

- Mount the GenStar MPPT indoors. Prevent exposure to the elements and do not allow water to enter the controller.
- Install the GenStar MPPT in a location that prevents casual contact. The GenStar MPPT heatsink can become very hot during operation.
- Use insulated tools when working with batteries.
- Avoid wearing jewelry during installation.

- The battery bank must be comprised of batteries of same type, make, and age.
- Certified for use in negative ground systems, or positive ground with floating array
- Do not smoke near the battery bank.
- Power connections must remain tight to avoid excessive heating from a loose connection.
- Use properly sized conductors and circuit interrupters.
- The grounding terminal is located in the case, and is identified by the symbol below:

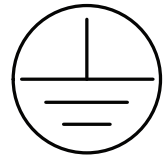

Ground Symbol

- This charge controller is to be connected to DC circuits only. These DC connections are identified by the symbol below:



Direct Current Symbol

A means of disconnecting all power supply poles must be provided. These disconnects must be incorporated in the fixed wiring.

The GenStar MPPT negative power terminals are common, and must be grounded as instructions, local codes, and regulations require.

A permanent, reliable earth ground must be established with connection to the GenStar MPPT ground terminal.

The grounding conductor must be secured against any accidental detachment.

- Servicing of batteries should be performed, or supervised, by personnel knowledgeable about batteries, and the proper safety precautions.
- Be very careful when working with large lead-acid batteries. Wear eye protection and have fresh water available in case there is contact with the battery acid.
- Remove watches, rings, jewelry and other metal objects before working with batteries.
 - Wear rubber gloves and boots
- Use tools with insulated handles and avoid placing tools or metal objects on top of batteries.
 - Disconnect charging source prior to connecting or disconnecting battery terminals.
 - Determine if battery is inadvertently grounded. If so, remove the source of contact with ground. Contact with any part of a grounded battery can result in electrical shock. The likelihood of such a shock can be reduced if battery grounds are removed during installation and maintenance (applicable to equipment and remote battery supplies not having a grounded supply circuit).
- Carefully read the battery manufacturer's instructions before installing / connecting to, or removing batteries from, the GenStar MPPT.
- Be very careful not to short-circuit the cables connected to the battery.

- Have someone nearby to assist in case of an accident.
- Explosive battery gases can be present during charging. Be certain there is enough ventilation to release the gases.
- Never smoke in the battery area.
- If battery acid comes into contact with the skin, wash with soap and water. If the acid contacts the eye, flush with fresh water and get medical attention.
- Be sure the battery electrolyte level is correct before starting charging. Do not attempt to charge a frozen battery.
- Recycle the battery when it is replaced.

ABOUT THIS MANUAL and PRODUCT INSTALLATION:

The GenStar MPPT controller must be installed by a qualified technician, in accordance with the electrical regulations of the country of installation.

Throughout this manual, NEC guidance is provided to meet general safety requirements, and to inform of best installation practices. It is the installer's responsibility to ensure that installation complies with all local safety and code requirements.

⚠ WARNING: Shock Hazard These installation and servicing instructions are for use by qualified personnel only. To reduce the risk of electrical shock, do not perform any servicing other than that specified in the operating instructions, unless qualified to do so.

1.1 TOOLS REQUIRED:



5/32" Hex wrench



Pencil



#2



3/32" (2.5 mm)



3/16" - load screws¹ (5 mm)



1/8" (3 mm) bit

MOUNTING:



¹ To prevent slippage or damage to the screw head, use a non-tapered, "hollow ground", 3/16" (5mm) bit tip flathead screwdriver.



2.0 GENERAL INFORMATION

2.1 Overview

Thank you for choosing the GenStar MPPT charge controller with TrakStar™ MPPT Technology. The GenStar MPPT is a maximum power point tracking solar battery charger. The controller features a smart tracking algorithm that finds and maintains operation at the power source's peak power point, maximizing energy harvest.

The GenStar MPPT battery charging process is designed for long battery life and improved system performance. GenStar MPPT is compatible with Lithium, Lead-acid, Ni-Cad and Flow battery systems. Self-diagnostics and electronic error protections prevent damage when installation mistakes or system faults occur. The controller also features several communication ports, and terminals for remote battery temperature and voltage measurement. See Ready Block BOS Components in Section 2.5 for details on data interface capabilities.

Please take the time to read this operator's manual to become familiar the many benefits the GenStar MPPT can provide for your PV systems. Some examples:

- Rated for 12 or 24, and 48 Volt systems, and 60, 80 or 100 Amps of charging current
- ReadyRail expansion system for relay operation, current monitoring and battery management
- Fully-protected with automatic and manual recovery
- Easily selectable preset charging profiles
- Continuous self-testing with fault notification
- LED indications, push-button and meter key functions
- Battery and PV Input terminals sized for #1/0 AWG (53.5 mm²) wire
- DC Load terminals sized for #6 AWG (13.3 mm²) wire
- Digital meter display
- 5-year warranty (see Section 7.0)

2.2 Versions and Ratings

There are three versions of the GenStar MPPT controller:

GenStar-MPPT-60

- maximum 60 Amps continuous battery current

GenStar-MPPT-80

- maximum 80 amps continuous battery current

GenStar-MPPT-100

- maximum 100 amps continuous battery current

All GenStar models:

- On-board meter display
- 30 Amp load current rating
- 12, 24 and 48 Volt DC systems
- Maximum 200 Volt DC open-circuit solar input voltage
- SD Card: USB-C (data port); RS-232, EIA-485, Ethernet (RJ-45), MS CANBus (not available with this release)

2.3 Features - Exterior

GenStar MPPT exterior and meter features are shown in Figures 2-1 and 2-2 below. A brief description of each feature follows the figures.

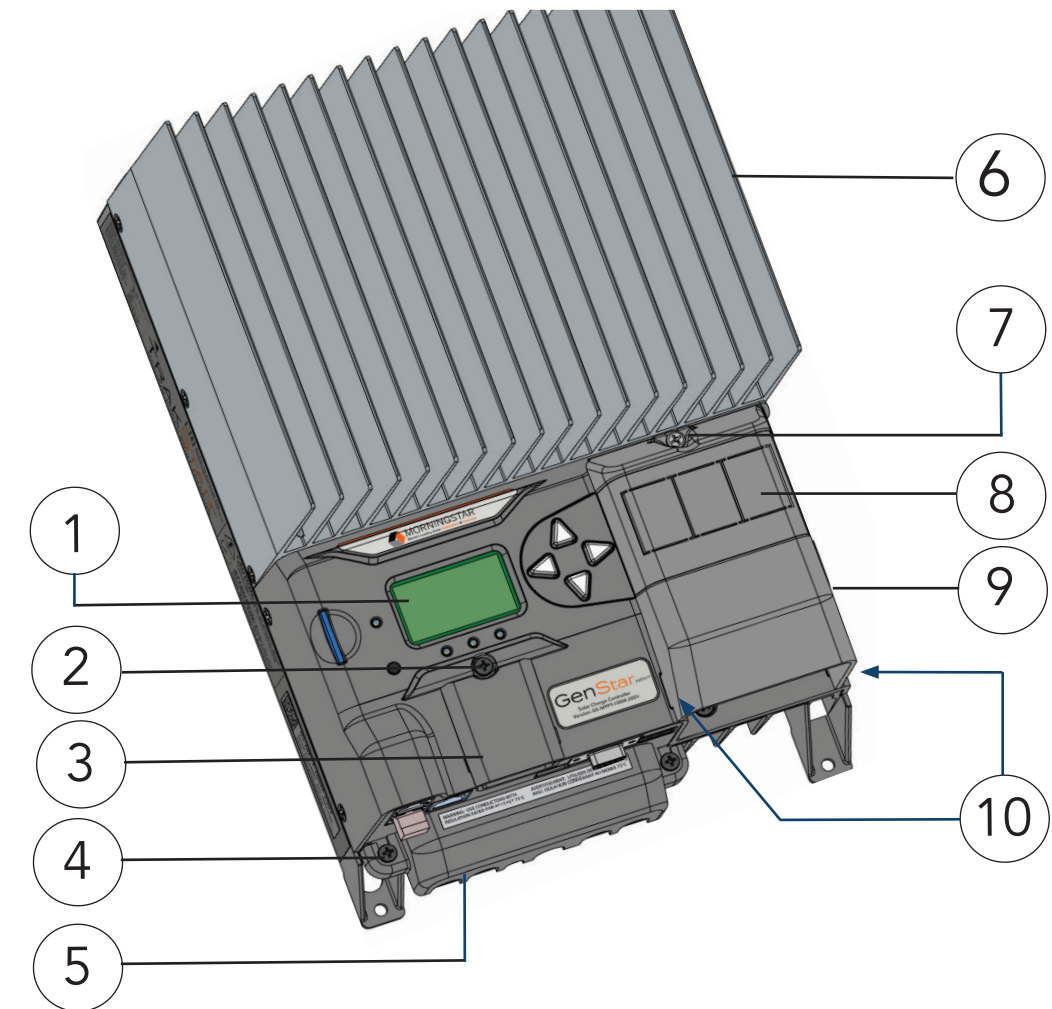

Figure 2-1. GenStar MPPT Exterior Features

EXTERIOR FEATURES:

1 - Meter Display Screen

LCD read-out for setting and programming navigation

2 - Coin Cell / Accessory Cover Screw

3 - Coin Cell / Accessory Cover

Plastic protective cover for accessory terminals and coin cell compartment

4 - Power Terminal Cover Screw (one of 2)

5 - Power Terminal Cover

Plastic protective cover for power terminal lugs and communication ports

6 - Heatsink

Aluminum heatsink to dissipate GenStar MPPT heat

7 - ReadyBlock Cover Screw

8 - ReadyBlock Tabs

Removable plastic protective panels for ReadyBlock installation

9 - ReadyBlock Cover

Plastic protective cover for ReadyBlocks and ReadyRail™

10 - ReadyBlock Cover Clips and Anchor Hole Locations

(2) Plastic extension flanges to secure cover in molded plastic anchors

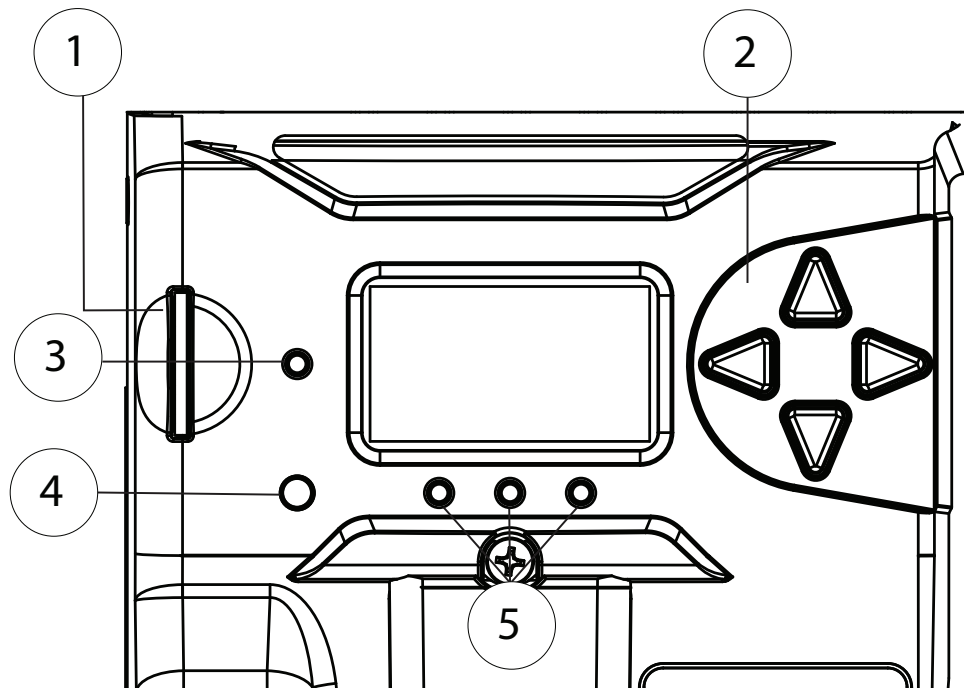

Figure 2-2. Meter Features

METER FEATURES:

1 - SD Card Slot - with SD card installed
External memory card slot for saving configurations and updating firmware

⚠ WARNING: Risk of Explosion
When loading a system image configuration from an SD Card, ensure that the destination device has the same system voltage, battery profile, and RTS; otherwise, there is a potential risk of system damage or bodily injury.

2 - Meter Directional Buttons
Meter navigational controls

3 - Status LED
Unit operational-fault indicator

4 - Programmable Soft-key
Push-button control for command activation

5 - State-of-charge LEDs
Approximate battery state-of-charge indicators

2.4 Features - Interior

GenStar MPPT exterior features are shown in Figure 2-3 below. A brief description of each feature follows the figure.

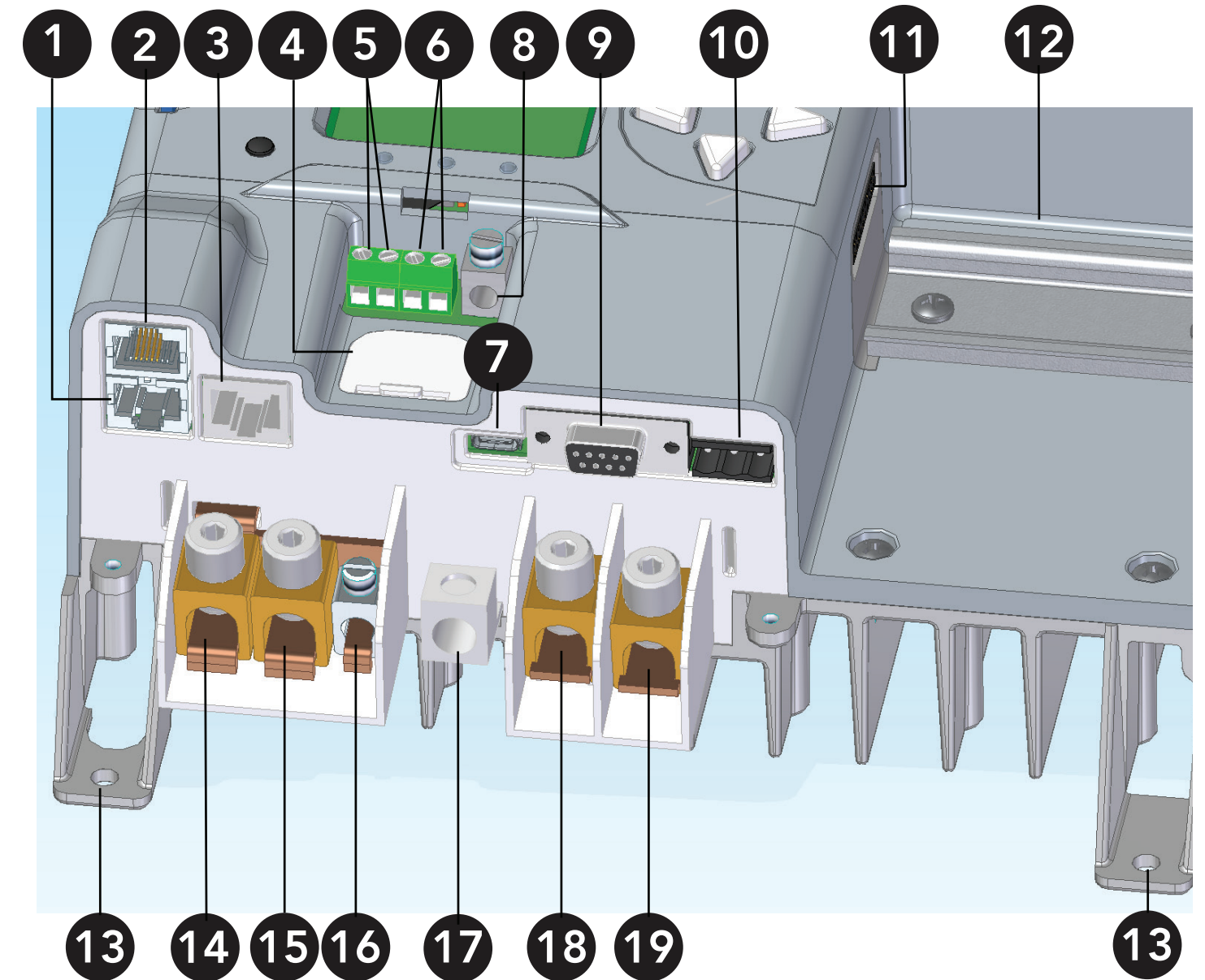

Figure 2-3. GenStar MPPT Interior Features

2.0

1 and 2 - MS-CAN In and Out Ports

Proprietary Morningstar device communication protocol ports

3 - Ethernet Port

RJ-45 socket for LAN/Internet connection

4 - Coin Cell (CR-2032)

Back-up battery for the real-time clock

5 - Battery Voltage Sense Terminals

Terminals for battery voltage input provide accurate battery voltage measurement

6 - Remote Temperature Sensor Terminals

Connection points for a Morningstar RTS to remotely monitor battery temperature

7 USB-C Port

USB-C data / Modbus port

8 - Positive Load Terminal Lug

Positive connection point for loads

9 - Serial RS-232 Port

9-pin serial connector (female DB9)

10 - EIA-485 Port

3-terminal connection for serial 485 networks (removable plug connector)

11 - ReadyRail Connection

20-PIN female *ReadyRail* connection interface for ReadyBlocks

12 - ReadyRail

Standard 35mm DIN mounting plate for mounting snap-in ReadyBlocks

13 - Lower Mounting Screw Holes (2)

Used to secure lower part of GenStar MPPT to the wall

14 and 15 - Battery/PV Common Negative Terminal

Connection points for battery or PV (-) power cable

16 - Negative Load Terminal Lug

Negative connection point for loads

17- Equipment Grounding Terminal Lug

Chassis grounding point for system equipment

18 - PV Positive Terminal Lug

Connection point for PV positive cable

19 - Battery Positive Terminal Lug

Connection point for battery positive cable

2.5 Optional Accessories

The following Morningstar accessories are available for purchase separately from your authorized Morningstar dealer:

Ground-fault Protection Device (GFPD-600V)

The GFPD-600V detects power source ground faults and interrupts current as required by the U.S. National Electrical Code.

READYBLOCK BOS COMPONENTS:

See product manuals at www.morningstarcorp.com/support/library/

ReadyRelay (RB-Relay)

The ReadyRelay is an expansion block that adds AC and DC-rated relay dry contact hardware functionality and firmware control and logic to the Morningstar GenStar MPPT charge controller.

ReadyShunt (RB-Shunt)

The ReadyShunt is an expansion block designed to measure and display net current flow into the battery, or to measure and display source or load auxiliary current.

ReadyBMS (RB-BMS)

The ReadyBMS provides simple visibility of battery performance, hands-free settings and optimized battery control. Through the ReadyBMS, the GenStar MPPT will report any data variable contained in the battery BMS. The Block can also interface with lithium batteries for, "closed loop", charging and data reporting.

3.0 INSTALLATION AND COMMISSIONING

3.1 General Installation Notes

- Read through the entire installation section first before beginning installation.
- Be very careful when working with batteries. Wear eye protection. Have fresh water available to wash and clean any contact with battery acid.
- Use insulated tools and avoid placing metal objects near the batteries.

⚡ WARNING: Equipment Damage or Risk of Explosion
Never install the GenStar MPPT in an enclosure with vented/flooded batteries. Battery fumes are flammable and will corrode and destroy the GenStar MPPT circuits.

⚡ WARNING: Risk of Fire
Over-current protection device **interrupt** ratings must be a minimum of 2kA, 3kA and 5kA for 12V, 24V, and 48V systems, respectively.

⚠ CAUTION: Equipment Damage
When installing the GenStar MPPT in an enclosure, ensure sufficient ventilation. Installation in a sealed enclosure will lead to over-heating and a decreased product lifetime.

⚠ CAUTION: Equipment Damage
When installing the GenStar MPPT be certain to observe correct polarity when wiring the battery to the controller battery terminals. **THERE IS NO REVERSE BATTERY POLARITY PROTECTION.**

⚠ CAUTION: Equipment Damage
The GenStar MPPT is designed to regulate **ONLY** solar (photovoltaic) power. Connection to any other type of power source e.g. wind turbine or generator may void the warranty. However, other power sources can be connected directly to the battery.

- For indoor use only. Do not install in locations where water can enter the controller.
- CSA C22.2 #107.1 requires the installer to apply the additional label: WARNING: WHEN A GROUND-FAULT IS INDICATED, BATTERY TERMINALS AND CONNECTED CIRCUITS MAY BE UNGROUNDED AND HAZARDOUS. per Clause 15.4.1.3 on or adjacent to the battery, in a location where it is visible prior to removal of guards, opening of a battery enclosure, etc.
- Be certain that battery terminals and other bare live parts of connected circuits are installed in enclosures or otherwise guarded against inadvertent contact.
- Loose power connections and /or corroded wires may result in resistive connections that melt wire insulation, burn surrounding materials, or even cause fire. Ensure tight connections and use cable clamps to secure cables and prevent them from swaying in mobile applications.
- Preset charging profiles are designed for lead acid and 4, 8 or 16 cell Lithium LiFePO4 batteries. Custom settings can be used for varied charging requirements (see section 5.2.2 for details). Note that some batteries may not be compatible.
- The GenStar MPPT battery connection may be wired to one battery, or a bank of batteries. The following instructions refer to a singular battery, but it is implied that the battery connection can be made to either one battery or a group of batteries in a battery bank.
- The GenStar MPPT uses corrosion-resistant fasteners, an anodized aluminum heat sink, and conformal coating to protect it from harsh conditions. However, for long service life, extreme temperatures and marine environments should be avoided.
- The GenStar MPPT prevents reverse current leakage at night, so a blocking diode is not required in the system.
- The maximum power wire size is 1/0 AWG / 53.5 mm² (multi-strand). Torque tightly up to 100 in-lb (11.3 N-m).

- The maximum equipment grounding terminal wire size is #2 AWG / 33.6 mm² (multi-strand). Torque tightly up to 50 in-lb / 5.65 N-m.
- The maximum load terminal wire size is #6 AWG / 13.3 mm² (multi-strand). Torque tightly up to 35 in-lb / 3.9 N-m.
- Use caution to ensure that all wire strands (especially fine strands) are contained in the terminal lug wire slot. Clamped wire heads are recommended for this purpose.
- Verify that the highest temperature compensated solar array open-circuit voltage (Voc) will not exceed 200V, and that load current will not exceed 30 Amps.
- Verify that the system battery will maintain voltages between 10-72.
- To achieve greater total charging current, multiple controllers can be installed in parallel on the same battery bank - sync charging is not available with initial release. Even with sync charging, each controller in the system must have its own solar array.
- The load terminals of multiple GenStar controllers can only be wired together if the total load draw does not exceed 30 Amps. See Section 4.4 for further details.
- Base array, charge controller, and battery bank specifications on accepted design-system sizing principles-recommendations.

3.2 Mounting - refer to Figures 3-1 and 3-2

⚠ CAUTION: Risk of Burns
Install the GenStar MPPT in a location that prevents casual contact. The GenStar MPPT heatsink can become very hot during operation.

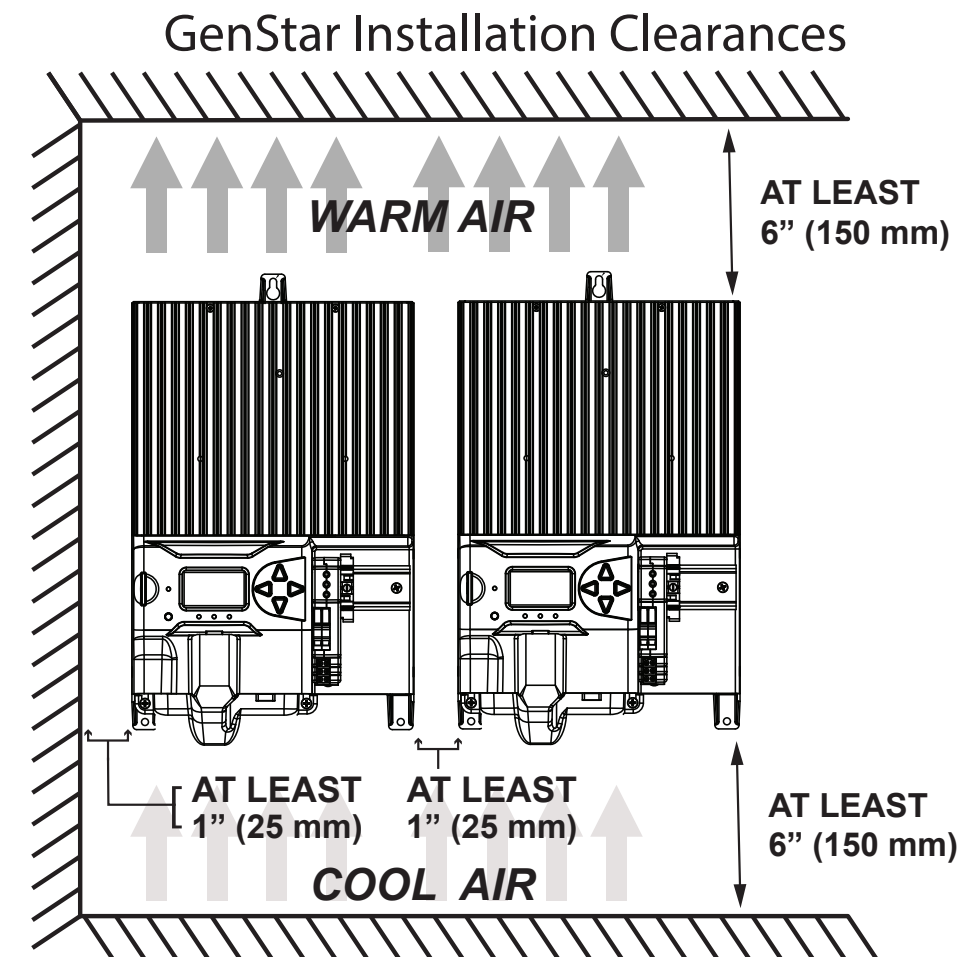

Figure 3-1. Required mounting clearance for proper air flow

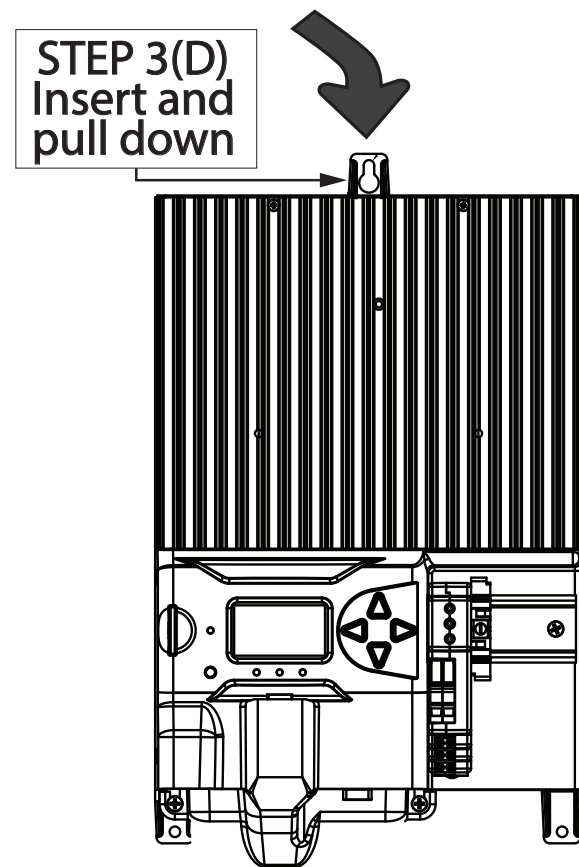

Figure 3.2 - Hanging GenStar using keyhole slot

Step 1: Choose mounting location

A) Locate the GenStar MPPT on a vertical surface that is protected from direct sun, high temperatures, and water.

Step 2: Wiring accessibility and air flow clearance

A) Plan and confirm wire routing-access.

B) Verify that there is at least 6" (150mm) of space above and below the unit, and at least 3" (75 mm) around the heatsink - see Figure 3-1.

Step 3: Drill holes and hang controller

A) Place the GenStar template on the wall where the unit will be mounted.

B) Mark and drill (1)-1/8" (3.175 mm) hole in the top end (slot) of the template keyhole, and (2) lower holes for the frame holes.

C) Drive a #10 screw (included) into the drill hole to 1/4 in. (6.35 mm) from flush with the wall.

D) Place the controller circular keyhole area over the wall screw, and pull the unit down to lock the screw into the slot.

Step 4: Finish securing the controller - use only panhead screws (included)

A) Drive the keyhole screw flush with the frame mounting hole.

B) Use two screws to secure the (2) unit lower frame holes flush with the wall.

3.3 Required Overcurrent Protection Devices (OCPD) and Disconnect Switches

NOTE: Definition

Overcurrent protection devices are defined as breakers or fuses. Strictly, a disconnect switch is device that only breaks a circuit - but provides no overcurrent protection.



WARNING: Shock and Fire Hazards

Installation must comply with all U.S. National Electrical Code, Canadian Electrical Code or local code requirements.



WARNING: Shock and Fire Hazards

Solar, load and battery overcurrent protection are required in the system. These protection devices are external to the GenStar MPPT controller, and must be sized as required by the NEC or local code requirements.



WARNING: Shock and Fire Hazards

The PV system requires a means of disconnecting the battery, PV array and load circuit(s). Breakers, or fused disconnect switches can serve as a means of disconnection, and should be at a readily accessible location. For best practices and safety guidance, see NEC 690, "Part III - Disconnecting Means", for disconnect requirements for PV systems, in addition to other code requirements.



WARNING: Shock and Fire Hazards

Fuses, single-pole circuit breakers, or single-pole disconnect switches must only be installed on ungrounded system conductors. The NEC allows and may require the use of double-pole breakers or double-pole disconnect switches which break both the grounded and ungrounded conductors of the PV array or load conductors.



WARNING: Shock and Fire Hazards

When using a disconnect switch, install a fuse or breaker in series to provide overcurrent protection.



CAUTION:

All breakers, fuses and disconnect switches must be rated for the maximum voltage of the circuit or higher. These devices are external to the GenStar MPPT controller.

BATTERY OVER-CURRENT PROTECTION DEVICE SIZING

The U.S. NEC requires the installation of DC breakers or fused disconnect switches in all battery circuits in order to provide both a means of disconnection and overcurrent protection.

The battery breaker or fused disconnect switch(es) should be located near the battery or the battery busbar. Where the controller battery terminals are more than 1.5m (5 feet) from the battery, or where circuits from these terminals pass through a wall or partition, U.S. NEC requires that a means of disconnection be provided at the battery and solar controller with overcurrent protection at the DC (battery) power source.

The minimum battery **disconnect switch** current rating is the current rating of the controller being installed. To provide over-current protection when using a disconnect switch, a properly sized fuse or breaker **must be** installed in series.

Battery breakers or fuses must be sized with a minimum of 125% of the continuous output current rating of the solar controller. Recommended battery circuit fuse or breaker current ratings:

MODEL	Battery Circuit Breaker/Fuse Rating
GS-MPPT-60M-200V	75 or 80 Amps
GS-MPPT-80M-200V	100 Amps
GS-MPPT-100M-200V	125 Amps

Table 3-1. Battery Circuit Breaker/Fuse Current Ratings Meeting U.S. National Electrical Code

PV INPUT OVER-CURRENT PROTECTION DEVICE (OCPD) AND DISCONNECT SWITCH RATINGS



WARNING: Shock and Fire Hazards

The solar array open-circuit voltage (V_{oc}) at the worst-case (coldest) module temperature must not exceed the PV disconnect or overcurrent protection voltage ratings.

As defined in NEC Section 690.9, PV input **disconnect switches** must have a current rating greater than or equal to the maximum PV array current (I_{sc}) multiplied 1.25. PV array $I_{sc} = \#$ of strings multiplied by the module I_{sc} (STC) rating.

Note that individual PV string circuits do not require disconnects.

NEC Section 690.9 provides requirements for **overcurrent protection**. These requirements are based on the maximum PV array current which equals 1.25 multiplied by array I_{sc} , as defined in NEC Section 690.9.

The PV input breaker or fuse rating should not be less than the next higher breaker rating above 156% of the PV array I_{sc} . Maximum PV breaker or fuse ratings are :

MODEL	Maximum PV Breaker or fuse Rating
GS-MPPT-60M-200V	80 Amps
GS-MPPT-80M-200V	100 Amps
GS-MPPT-100M-200V	125 Amps

Table 3-2. PV Input Circuit Maximum Breaker or Fuse Current Ratings

String breakers or fuses are also required for parallel strings and are typically included with the PV string combiner.

- There may be other code requirements specific to the installation of a particular PV array.

As allowed for in NEC Section 690.9(A), PV input overcurrent protection is not required if both of the following conditions are met:

- 1) PV wire ampacity is sufficient to carry the maximum PV array current (ampacity is greater than 156% of PV array I_{sc})
- 2) The maximum PV array current (125% of PV array I_{sc}) is less than the maximum input I_{sc} current rating of the controller and PV disconnect rating.

If 156% of PV array I_{sc} is greater than the maximum PV input breaker or fuse current rating, the PV array breaker or fuse should be located at the output of the PV array combiner.

Load Output Overcurrent Protection Devices (OCPD) and Disconnect Switches

The output/load breaker or fuse rating must be no greater than 40 Amps.

The load fuse or breaker must be sized at a minimum of 125% of the maximum load output current. The maximum load output current is the sum of the branch load circuits or the controller load output current rating.

The load/output breaker or fused disconnect switch should be located near the load output terminals of the controller.

The load output disconnect switch must have a minimum current rating greater than or equal to the fuse current rating, but is not required to be higher than the load output current rating of the controller.

3.4 Wiring



WARNING: Fire Hazard

If multiple units are used in parallel for more charging current, the battery conductor wiring must be sized for the total sum of all current ratings of the combined controllers.



CAUTION:

U.S. installed wiring must conform to all current U.S. NEC, ANSI/NFPA 70 requirements, and to any local regulations. Non-U.S. installations must meet all national and local requirements of the country of installation.

Before connecting any wires, read the instructions in Section 3.4, and lay out the lengths and routes needed.

When wiring, secure and contain wire runs as required by code.

(3) ferrite chokes are included for individual installations around an RTS cable, PV (+) and (-) cables (in one choke) and Ethernet cable. See Figures 3-3 and 3-4 for installation details conforming to FCC Class B EMI requirements. Each core must be installed as close to the GenStar MPPT as possible.

Proper wire type and size is required for all installations. **Use only UL-listed Class B or Class C stranded wire rated for 300 Volts and 75°C or higher. Copper wire** is recommended vs. aluminum due to its ease of use, superior conductivity, strength and thermal expansion properties.

Battery and PV input terminal sizes:

8 - 1/0 AWG (10 - 53.5mm²)

Load terminal wire sizes:

14 - 6 AWG (2.5 - 13.3mm²)

Conductor ampacity (current carrying capacity) **must be** greater than the maximum current expected in the power circuits.

Accepted practice for system design requires that DC conductors are sufficiently sized to limit voltage drop losses to 2% or less. The table in Appendix C provides wire sizing information and distances for required maximum 2% voltage drop in GenStar MPPT wiring applications.

Also see Appendix C, "Wire Sizing", for copper wire sizing instructions, including minimum wire sizing requirements.

Accessory Wiring - refer to schematic in Figure 3.3 below when following 3.4.1 and 3.4.2 on next pages.

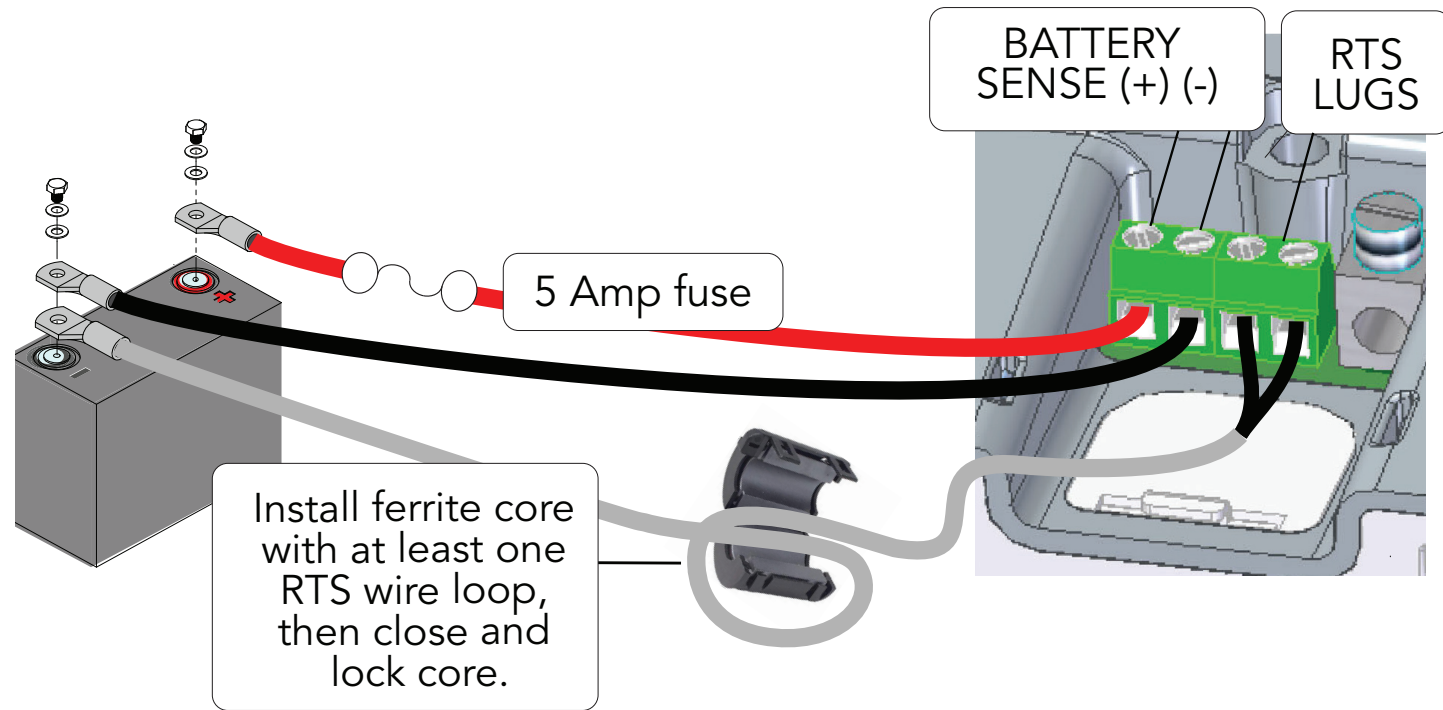

Figure 3-3. Accessory installation detail

3.4.1 Battery Voltage Sense Wires - refer to Figure 3-3 above



WARNING: Fire Hazard

When connecting Battery Sense Wires, install a 5 Amp fuse in the (+) sense wire, within six inches (150 mm) of the (+) battery terminal.

Due to connection and cable resistance, voltage drops are unavoidable in all power cables that carry current. If Battery Sense wires are not used, the controller must use the voltage reading at the battery power terminals for regulation. This voltage may differ from the actual battery bank voltage due to voltage drop.

Battery Voltage Sense is a high impedance connection that enables the GenStar MPPT to measure the battery terminal voltage precisely with small gauge wires that have no voltage drop. When connected directly to the battery, the sense wires will improve battery charging accuracy. Battery voltage sense wires are recommended, but may not be necessary when using larger battery cables and/or shorter battery wire lengths.

Generally accepted wiring practice is to limit voltage drops between the charger and the battery to 2%. Even properly sized wiring with 2% drop can result in a 0.3 volt drop for 14.4V charging. Voltage drops will cause some undercharging of the battery.

The controller will begin Absorption or limit equalization at a lower battery voltage because the controller measures a higher voltage at the controller's terminals than is the actual battery voltage.

For example, if the controller is programmed to start Absorption at 14.4V, when the controller, "sees", 14.4 volts at its battery terminals, if there is a 0.3 volt drop between the controller and battery, the true battery voltage would only be 14.1 volts.

Note that the battery sense wires will not power the controller, and the sense wires will not compensate for losses in the power wires between the controller and the battery. The battery sense wires are used to improve the accuracy of the battery charging.

The two sense wires, can range in size from 1.0 to 0.25 mm² (16 to 24 AWG), and should be cut to length as required to connect the battery to the voltage sense terminals. The 2-position terminal - to the left of (beyond the RTS terminals) the Load (+) terminal (see Figures 3-3 and 3-4) is used for the battery sense connections. A twisted pair cable is recommended but not required. Use UL rated 300 Volt conductors. The voltage sense wires may be pulled through conduit with the power conductors.

Observing correct polarity, connect both battery voltage sense wires to the GenStar MPPT at the 2-position Battery Sense terminal, and to battery (+) and (-) terminals. No damage will occur if the polarity is reversed, but the controller cannot read a reversed sense voltage.

Tighten the connector screws to 5 in-lb (0.56 N-m) of torque.

The maximum length allowed for each battery voltage sense wire is 98 ft (30 m).

Connecting the voltage sense wires to the RTS terminal will cause an alarm.



NOTE: If the battery input voltage is greater than 5 Volts different from the Battery Sense, due to voltage drops or faulty connections, the Battery Sense input will not be recognized by the GenStar MPPT. An alarm will be set until the condition has been corrected.

Although not required to operate the GenStar MPPT controller, a battery voltage sense connection is recommended for best performance.

3.4.2 Remote Temperature Sensor With Ferrite Choke - refer to Figure 3-3 above

above

CAUTION: Equipment Damage

To enable temperature compensation settings (mV/ °C) which are required for **Lead-acid** batteries, an RTS must be used. Otherwise, charging will be based on a temperature of 25°C. Use of an RTS is strongly recommended.

An RTS can be added at any time during system installation.

All **lead-acid** battery charging settings are based on 25°C (77°F). The GenStar MPPT default Lead-acid battery temperature compensation presets are -30mV/ °C @ 12V. This means that if the battery temperature varies by just 5°C, the charging target regulation voltage should change by 0.15 Volts for a 12 Volt battery. This is a substantial change in battery charging, so it is important to always use the included Remote Temperature Sensor (RTS) with lead-acid batteries.

Lithium batteries do not require temperature compensation. Therefore, temperature compensation is disabled for all of the GenStar MPPT lithium battery presets. However, if the lithium battery temperature drops below freezing or becomes very hot during charging, it can cause irreversible harm to the battery. Therefore, where the battery temperature can get excessively low or high, it is important to use the low or high temperature foldback settings together with an RTS. During these conditions, the foldbacks will allow charging to taper off or become disabled. All of the GenStar lithium battery presets include low temperature foldback settings. See Configuration Section 4.2.5 for details on foldback settings.

CAUTION: The RTS must be used to enable low and high temp foldback settings which are often used with lithium batteries.

WARNING: Equipment Damage

Never place the temperature sensor inside a battery cell. Both the RTS and the battery will be damaged.

NOTE: The RTS cable may be shortened if the full length is not needed. If a length of cable is removed, be sure to re-install the ferrite choke on the RTS cable as close as possible to the controller. This choke ensures compliance with electromagnetic emissions standards.

INSTALLATION:

Connect the RTS to the 2-position terminal located immediately to the left of the Load (+) terminal (see Figures 3-3 and 3-4).

The RTS is supplied with 33 ft (10 m) of 22 AWG (0.34 mm²) cable. There is no polarity, so either wire (+ or -) can be connected to either screw terminal. The RTS cable may be pulled through conduit along with the power wires. Tighten the connector screws to 5 in-lb (0.56 N-m) of torque. Separate installation instructions are provided inside the RTS bag.

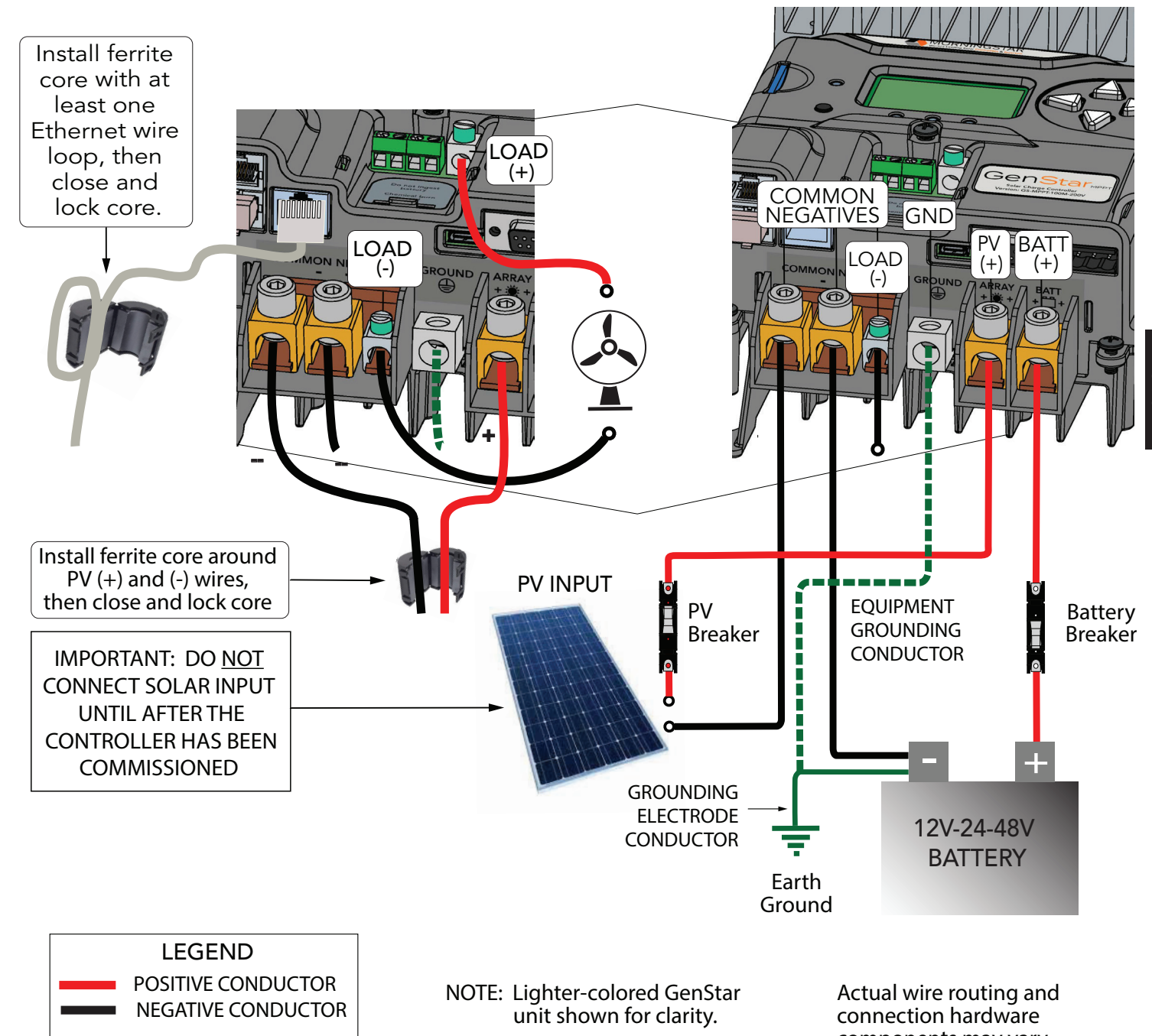

Figure 3-4. GenStar MPPT Power Wiring

3.4.3 Grounding and Ground Fault Interruption - refer to Figure 3-4 above

For safety, and effective lightning protection, it is recommended, and may be required by code, that the negative conductor of the charging system be properly grounded. Do not connect the negative system wire to the case grounding terminal. The GenStar MPPT does not have internal ground fault protection; but where the NEC requires the use of a ground fault protection device (GFPD), **the system electrical negative must be bonded through a GFPD to earth ground at only one point.**

SYSTEM GROUNDING

The DC system should be bonded to ground with a connection to the primary battery circuit. It can be bonded to ground directly or through an AC service panel if there is an inverter installed in the system. For the DC system grounding electrode conductor (GEC) sizing requirements, refer to NEC Section 250.166, or applicable local regulations or code.



WARNING: Shock Hazard

This unit is not provided with a GFDI device. This charge controller must be used with an external GFDI device as required by the Article 690 of the National Electrical Code for the installation location.



WARNING: Shock Hazard

When a ground fault is indicated, battery terminals and connected circuits might be ungrounded and hazardous..



WARNING: Risk Of Electrical Shock.

NO POWER OR ACCESSORY TERMINALS ARE ELECTRICALLY ISOLATED FROM DC INPUT, AND MAY BE ENERGIZED WITH HAZARDOUS SOLAR VOLTAGE. UNDER CERTAIN FAULT CONDITIONS, BATTERY COULD BECOME OVER-CHARGED. TEST BETWEEN ALL TERMINALS AND GROUND BEFORE TOUCHING.



NOTE:

Follow local electrical installation code and use green/yellow, green or transparent insulated grounding-earthing wire.

EQUIPMENT GROUNDING

Use copper wire to connect the grounding terminal in the case, and other dead metal, to earth ground. The grounding terminal is identified by the ground symbol on the case, just above the terminal, as shown below:

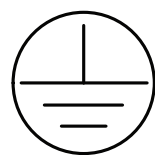

Ground Symbol

Recommended minimum sizes for equipment copper grounding wire:

- GenStar MPPT-60 8 AWG (8.37 mm²)
- GenStar MPPT-80 6 AWG (13.3 mm²)
- GenStar MPPT-100 4 AWG (21.1 mm²)

3.4.4 BATTERY CONNECTIONS - refer to Figure 3-4 above

STEP 1: Before wiring, verify that all system breakers and disconnect switches are in the OPEN/DISCONNECTED position, and that all fuses are removed from their holders.



WARNING: SHOCK HAZARD - LIVE EQUIPMENT GROUND CONNECTION

Keep the battery (-) cable and GEC disconnected from the battery bank (-) post while installing the system or while system wires are exposed.



CAUTION: Equipment Damage

Locate battery breakers or fused disconnects for easy access and free from hydrogen gas/sulfuric acid fumes.

STEP 2:

(A) Fit a positive wire between the battery bank (+) post or busbar and the GenStar battery (+) terminal.

(B) Using a short wire on the battery side, install a correctly sized in-line breaker or fused disconnect switch in the OPEN position as close to the battery (+) post or busbar as possible.

(C) Connect the long wire from (A) to the vacant breaker terminal from (B), and then the other end to the GenStar battery (+) terminal.

(D) Where GenStar battery terminals are more than five (5) feet from the battery, or where circuits from these terminals pass through a wall or partition, U.S. NEC requires that overcurrent protection be provided at the solar controller in addition to providing overcurrent protection at the DC battery power source.

STEP 3:

(A) Fit a negative wire between the battery (-) post and GenStar MPPT battery (-) terminal.

(B) Connect the controller end to the GenStar battery (-) terminal. **DO NOT CONNECT THE BATTERY END OF THE NEGATIVE WIRE AT THIS TIME.**

3.4.5 SOLAR CONNECTIONS - refer to Figure 3-4 above



WARNING: SHOCK HAZARD - LIVE EQUIPMENT GROUND CONNECTION

Keep the PV array (-) wiring disconnected during installation, and when system wires are exposed.

STEP 1: Wire the PV array according to NEC Section 690 or applicable local regulations or code. Use caution, since the solar array will produce current whenever it is in sunlight.

STEP 2: According to the combiner installation instructions, wire the PV array string (+) wire(s) to a solar combiner box that includes fuse holders or breakers. **DO NOT INSTALL COMBINER FUSES OR CLOSE COMBINER BREAKERS AT THIS TIME.**

STEP 3: Fit and connect a positive wire between the GenStar PV input (+) terminal and the OPEN/DISCONNECTED combiner PV (+) disconnect switch or breaker. **DO NOT CLOSE THE DISCONNECT AT THIS TIME.**

STEP 4: Fit and connect a negative wire between the GenStar PV (-) input terminal and the PV (-) busbar or combiner terminal. **DO NOT CONNECT THE ARRAY STRING (-) WIRE(S) TO THE COMBINER BOX AT THIS TIME.** This can be achieved by not connecting the PV (-) MC-4 connectors or the PV (-) wire(s) to the transition box, combiner box or the PV (-) disconnect.

3.4.6 LOAD CONNECTIONS - refer to Figure 3-4 above

⚠ CAUTION: Equipment Damage

Do not wire any AC inverter to the load terminals of the GenStar-MPPT. Damage to the load control circuit may result. An inverter should be wired directly to the battery. If there is a possibility that any other load will sometimes exceed the GenStar's maximum load current rating, the device should be wired directly to the battery or battery bank. If load control is required, contact Morningstar Technical Support for assistance.

STEP 1: OPEN any load disconnects or breakers, and turn OFF any loads.

STEP 2: Connect positive and negative wires to the load, and to any load bus bars or load panel terminals.

STEP 3: Install a correctly sized load/output breaker or fused disconnect switch in the OPEN position located near the load output terminals of the controller.

STEP 4: Connect the positive and negative load wires (either directly, or from a junction) to the GenStar load terminals.

DO NOT CLOSE ANY LOAD DISCONNECTS OR BREAKERS AT THIS TIME.

3.4.7 READY BLOCK INSTALLATION

For complete documentation, refer to each Ready Block's installation and operation instructions.

As seen in Figure 2-1, and then as described in Section 2.3:

- A) Loosen screw (7)
- B) Remove the cover (9) by pressing in the tabs (10)
- C) Use a knife to cut out the dead panels (8) for each corresponding block being installed

BMS BLOCK NOTES:

Only one BMS Block is supported per system. If multiple BMS blocks are present, a system alarm will trigger and a status message will indicate which of the BMS blocks is active for collecting data from a BMS-battery

FURTHER:

- When using a BMS block, only a single battery (or a bank of parallel batteries) is supported in a network of host controllers.
- When using a BMS block, only a single manufacturer of batteries is supported. If the battery-bank is changed to a new manufacturer, the user only needs to change the battery configuration type for the BMS block.
- When using a BMS block, only a single battery model is supported. If a network of parallel batteries is employed, to work properly with the BMS block, all of the batteries must be of the same model.

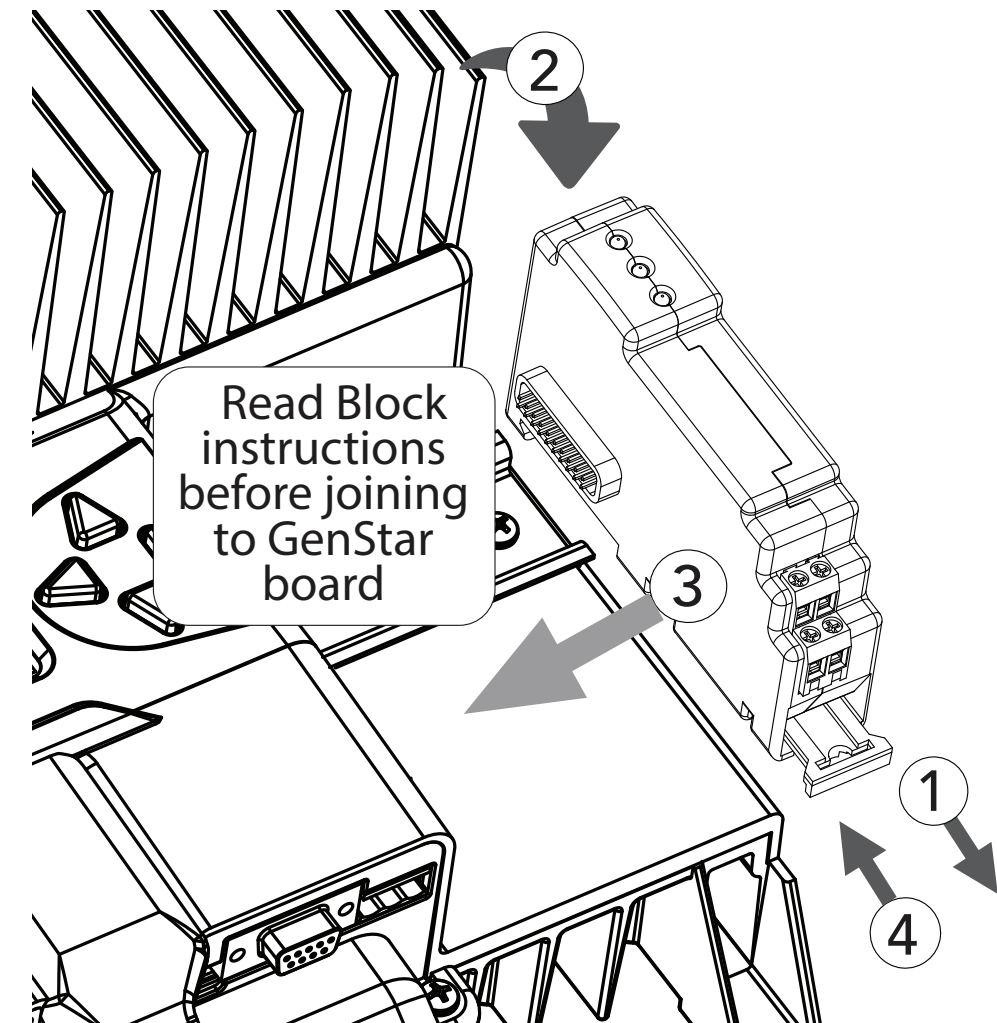

Figure 3-5. Ready Block Installation - refer to separate Block documentation for complete instructions

3.4.8 Final Connections



WARNING: Equipment Damage

Connecting the battery cables with reverse polarity will permanently damage the GenStar.

STEP 1: Confirm that the battery wire polarity is correct, and that the fused battery disconnect switch or breaker are in the OPEN position. Connect the system battery (-) cable to the GenStar battery (-) terminal. If the system is to be grounded at the battery, make the GEC connection at the battery (-) post also.

STEP 2: Confirm that the PV array wire polarity is correct, and that the fused PV disconnect switch or breaker is in the OPEN position. Connect the PV array (-) negative wire(s) to negative combiner box connection or PV(-) disconnect.

STEP 3: With all disconnects and system breakers OPEN/OFF, insert properly sized battery, PV and load fuses - where applicable - into the fuse holders.

STEP 4A: To verify correct battery wiring voltage and polarity, test the voltage between the (+) battery side of the battery breaker or fused switch and a GenStar (-) terminal.

STEP 4B: To verify correct solar wiring voltage and polarity, test the voltage between the array side of the PV (+) fused switch or breaker, and a GenStar (-) terminal.

3.4.9 Power-Up and Verify System Operation



NOTE: Carefully observe the LEDs after each connection. The LEDs will indicate proper polarity and good connections.

To power ON the controller, CLOSE the battery breaker or fused disconnect switch. Watch and verify that the Charging Status LED lights solid green, and then the three battery state-of-charge (SOC) LEDs blink in sequence (G-Y-R), confirming proper start-up. If they do not light, check the battery polarity (+/-) and battery voltage.

Next, the green, yellow or red LED will light depending on the battery state-of-charge (SOC). Confirm that one of these LEDs is on before going to the next step.

CLOSE the fused solar disconnect switch or breaker. If the solar input is connected while in sunlight, the charging LED indicator will light.

Confirm proper connection by observing the charging LED.

CLOSE the fused load disconnect switch or breaker, and turn the load ON to verify a proper connection.

If the load does not turn on, it could be for various reasons:

- the GenStar MPPT is in LVD (red LED on)
- there is a short circuit in the load (LEDs blinking R/G – Y)
- there is an overload condition (LEDs blinking R/Y - G)
- the load is not connected, not working, or turned off

After all connections have been completed, observe the LEDs to make sure the controller is operating normally for system conditions.

3.4.10 To Power-down



WARNING: Equipment Damage

ONLY disconnect the battery from the GenStar MPPT **AFTER** the solar input has been disconnected. Damage to the controller may result if the battery is removed while the GenStar MPPT is charging.

OPEN the solar disconnect switch or breaker.

TEST the voltage between the PV side and other side of the disconnect switch or breaker to ensure that ISOLATION from the solar input has been achieved.

If a load is connected, OPEN the load disconnect or breaker.

OPEN the battery circuit breaker or disconnect switch to ISOLATE the controller.

3.5 Commissioning / Initial Configuration

Commissioning requires the user to enter and confirm important settings required for basic operation. See commissioning sections below. For all other settings, see Configuration Section -4- for complete details on LiveView and programming. These settings beyond commissioning can be made using LiveView, or the local meter (with some limitations).

3.5.1 Methodology

Commissioning can only be done via the local meter.

3.5.2 Commissioning Menu

The commissioning menu - see Figure 3-6 below - only appears on first start-up from the factory, and after a, "Factory Reset", of the GenStar MPPT. The directional arrows are used to navigate vertically and horizontally through the meter display map. In the commissioning menu, the right arrow is used to move to a screen to adjust the setting.

3.5.3 Stand-alone Commissioning Settings

The current GenStar operates only as a stand-alone controller, and must be programmed with preset or custom settings. The GenStar cannot currently be programmed to operate in a synchronized mode with other controllers in the system.

The commissioning flowchart in Figure 3-6 below illustrates the selectable options required to prepare the GenStar MPPT for operation or further programming.

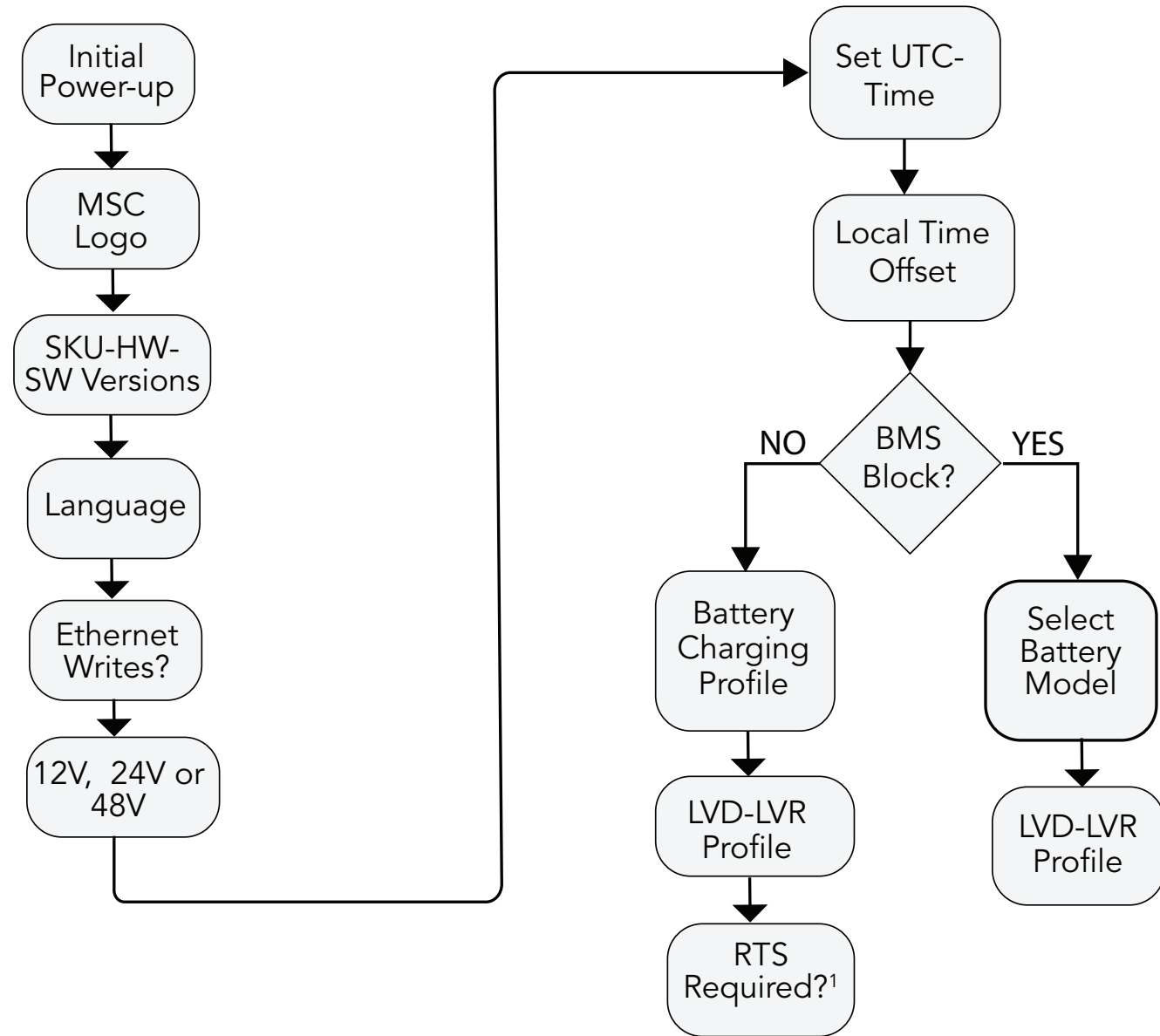

¹ "RTS Required", is the default setting. Once a unit is commissioned with this default, a subsequent change to, "RTS not required", necessitates that the unit be re-commissioned via a Factory Reset using the local meter - Installer Setup\Commands\Factory Reset. Also see RTS Start-up and Run-time Behavior Tables below.

Figure 3-6 -Commissioning Flowchart

RTS START-UP and RUN-TIME BEHAVIOR TABLES

START-UP BEHAVIOR	RTS REQUIRED - YES (default setting)	RTS REQUIRED - NO (default must be changed in factory reset-new commissioning)
RTS not connected at start-up	Fault - no charging	Normal charging using 25°C
RTS connected at start-up	Normal charging using RTS temperature	Normal charging using RTS temperature

Table 3-3. GenStar MPPT Start-up Behavior

RUN-TIME BEHAVIOR	RTS REQUIRED - YES (default setting)	RTS REQUIRED - NO (default must be changed in Installer Setup)
RTS disconnected	Fault - no charging	CONTINUED CHARGING AT 25°C ref. - ALARM SET
RTS reconnected	Clears fault, then normal charging using RTS temperature	Normal charging using RTS temperature

Table 3-4. GenStar MPPT Run-time Behavior

4.0 CONFIGURATION

4.1 Adjusting Settings

All settings - excluding factory reset and controlling Ethernet writes - can be configured using Morningstar LiveView web pages. See the main LiveView web page for locations and screens. The configuration sections describe all settings details in terms of LiveView screens, and many settings are also accessible within the Setup-Installer Setup on-board meter menus shown below in Figure 4-1.



CAUTION:

To effect changes, always use the **Save Button** in upper right corner of the settings area.

4.1.1 Using the Meter Display

To adjust LCD display appearance, menu-screen behavior, language, use the Display and Button menu.

Structure and Navigation (see Figure 4-1)

Four lighted triangular directional control keys allow movement to reach any desired point on the meter layout. A lit key indicates a valid direction in the layout. The current location is indicated on the display with a column heading, and a bold descriptor.

Using the horizontal arrows buttons, the user can scroll right to access more settings, or left to return to the previous screen. Pressing the down arrow button will move to the next lower listing. From a main screen, pressing the up arrow will return to the next main screen up. Scrolling down will continue to move through the subsequent main menu listings. Scrolling to the right, and then down, allows the user to advance to new options in branches and sub-branches. Scrolling to the left will return to the previous menu listing.

Programmable Soft-key (maps command functions)

The Soft-key button is located at the lower left corner of the meter interface (see Figure 2.2 in Section 2.3). The button can be programmed to control up to two commands - one command with a momentary press, and another with a prolonged (>2 sESC) press. Soft-key commands can be programmed in the Commands Menu on the Meter Display, and in LiveView Installer Setup. See Sections 4.2.7, #5, 4.2.9 and 5.4 for details about Soft-key Commands.

Accessing Installer Setup

From the Setup menu, scroll down to, and select, Installer Password. Use the directional arrows to enter the 3-digit Installer Password (141).

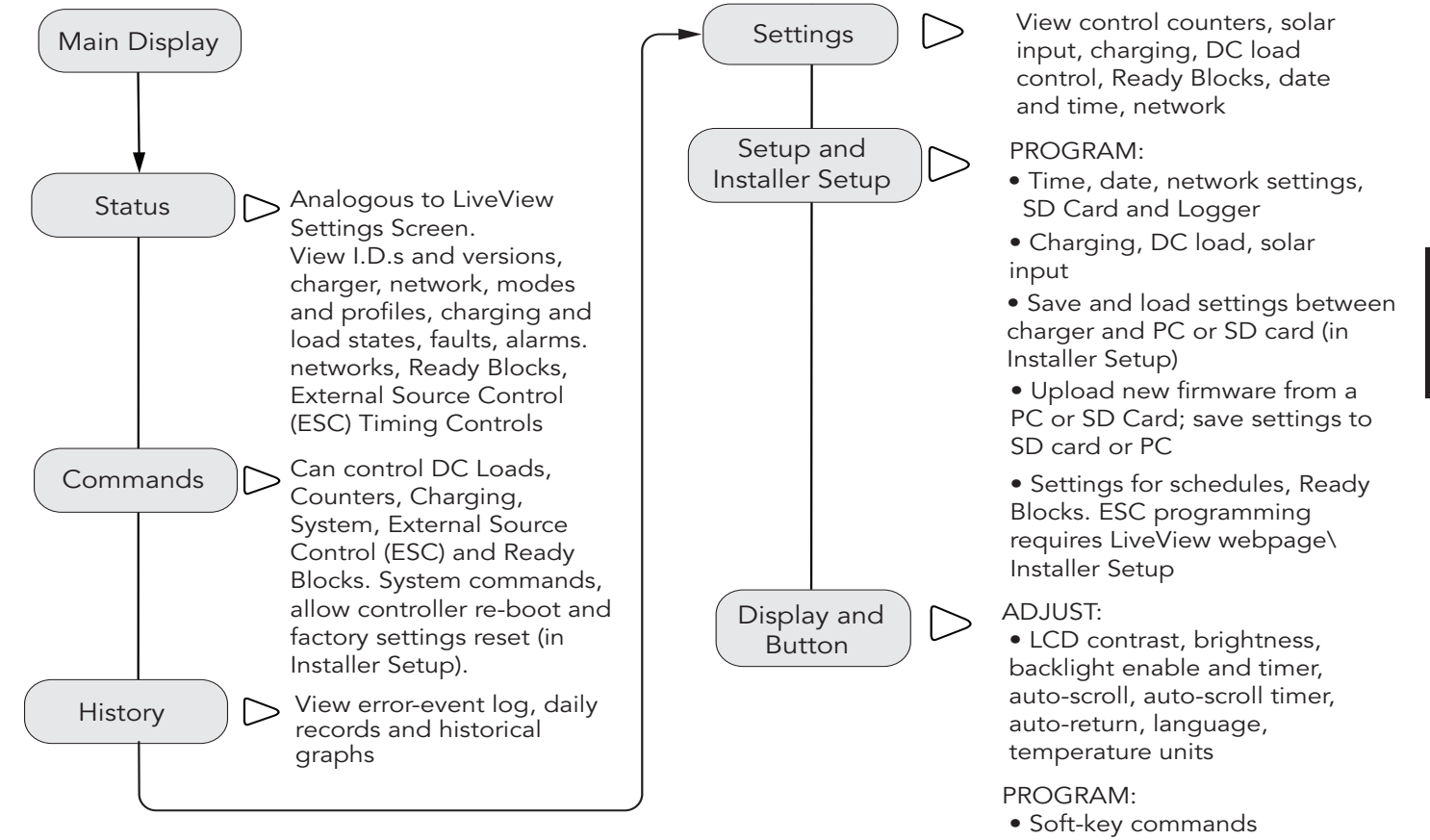

Figure 4-1. Main Local Meter Display Menus

4.1.2 Using the Mobile App

A mobile app is available for use with Android or iOS devices, and can be downloaded to a mobile device from either the Google Play Store (Android) or the Apple App Store (IOS).

The application uses Bluetooth LE to communicate with the GenStar, and replicates the Morningstar LiveView webpage (see Section 4.1.3 below).

The mobile app includes much of the functionality seen in the LiveView sections described below.

4.1.3 Using the LiveView UI

LiveView is an interface that serves Morningstar application web pages directly from the GenStar MPPT. The web pages closely coincide with the GenStar MPPT meter layout and functions.

GenStar cannot be commissioned using LiveView. Commissioning requires use of the unit's meter interface. The various LiveView-local meter categories, and their uses, are summarized in Figure 4-1 above.

The GenStar MPPT has an RJ-45 Ethernet port for connection to a LAN/WAN. For temporary LiveView setup, a Cat 5 or 6 Ethernet cable can be connected between a PC/laptop and a GenStar MPPT Ethernet port. If the GenStar MPPT was connected to the LAN during installation, LiveView can be accessed via LAN/wireless connection.

A DHCP-enabled router will automatically assign an IP address and network settings to the GenStar MPPT. After the original assignment, network settings can be changed using LiveView Setup\Network or Installer Setup\Network page, if desired.

Using a Web browser, the GenStar MPPT's LiveView Web pages can be accessed via two methods:

- 1) Enter the *GenStar MPPT's* IP address into the Address bar, e.g., <http://192.168.1.253>. The IP address can be found in the meter display in Settings\Network.
- 2) Scan the QR code on the serial label with a mobile device or enter the GenStar MPPT's NetBIOS name [product abbreviation + 8-digit serial no.] into the address bar, e.g., <http://GSMPPT22070007> - GenStar product abbreviation is GSMPPT.

4.1.4 LiveView Screen

The LiveView Screen shows five real-time cards:

- Battery Flow Diagram - showing Charge, Battery and Load summaries
- Array Details - showing array voltage, current, MPPT sweep values, and charge moved, charging current and charging power
- Charge Controller Details - showing battery charging state, net charging current, voltage and heatsink temperature
- Ready Blocks - showing up to (3) ReadyBlocks: Shunt ratings, Relay assignments, BMS system details
- Errors - showing daily and total set faults and alarms

4.1.5 Settings Screen

The Settings Screen displays all informational and configured system details. The screen is divided into the following areas:

- IDs and versions: View firmware and hardware versions, serial number, key, user interface version and UI build date
- Charger: View battery/bank size and all charging parameters
- Network: View all network names, addresses, IDs and time servers
- Meter Display: View all screen settings, languages, units and programmed soft-key functions
- Modes and Profiles: View operating mode, ESC mode, battery profile, LVD-LVR profile

- DC Load: View all low voltage disconnect (LVD) and reconnect thresholds, LVD and SOC disconnect timers, SOC disconnect and reconnect percentages, load current compensation value
- Solar Inputs: MPPT, fixed voltage, or percentage of Voc
- Ready Blocks: Check type of block in each of three positions - an indication of, "Empty", is shown if no blocks are installed in a position.
- External Source Timing Controls: View settings for Primary Generator Warm-up Time, Primary Generator Cool-down Time, Primary Generator Max. Run-time, Primary Generator Min. Run-time

4.2 Setup and Installer Setup

Setup settings are available in both Setup and Installer Setup. Setup allows only limited system settings, schedule programming, and other non-critical adjustments. Setup can be used by non-installers and operators. Installer Setup offers four additional categories of higher level programming. See Sections 4.2.4, 4.2.5, 4.2.7 and 4.2.8 for full details.



CAUTION:

The GenStar MPPT is currently read-only over a network. For security purposes, the, "MODBUS writes over Ethernet", enable/disable setting can only be modified on the local meter display.

Several Installer settings are originally chosen during commissioning, but changes can be made in Installer Setup categories after the Installer Password 141 has been entered. Installer settings also include the six (6) basic setup topics described below.

- 4.2.1 Date and Time (Setup and Installer Setup)
- 4.2.2 Network Settings (Setup and Installer Setup)
- 4.2.3 SD Card and Logged Data (Setup and Installer Setup)
- 4.2.4 Load Control (Installer Setup)
- 4.2.5 Charger (Installer Setup)
- 4.2.6 Schedules (Setup and Installer Setup)
- 4.2.7 Ready Blocks (Installer Setup)
- 4.2.8 External Source Control/ESC (Installer Setup)
- 4.2.9 Display and Button (Setup and Installer Setup)
- 4.2.10 Save and Load (Setup and Installer Setup)

4.2.1 Date and Time (Setup and Installer Setup)

UTC (Universal Time Coordinated) is set at the factory. If the coin cell remains in place, UTC may not need adjustment. Conduct a web search for, "current UTC time", to confirm time is set correctly. Set the *Date* and *Time* in Installer Setup\Date and Time. The internal precision clock is used for log data time-stamping, ESC control, schedules, and other time-based functions. There are two options for keeping accurate time:

- 1) Internal clock uses the GenStar MPPT's built-in real-time clock. The coin cell battery allows *Time* and *Date* to be retained through power cycles. If using the internal clock, UTC time and date are entered, and an offset for local time zone is entered. Note that the local offset must be adjusted when a time zone changes to DST, and back.

2) Time server - if the GenStar MPPT is connected to the Internet, it has the ability to periodically update time and date from a time server(s). Go to Installer Setup\Network to specify up to three (3) time server addresses.

4.2.2 Network Settings (Setup and Installer Setup)

If the GenStar MPPT is connected to a DHCP router, and the DHCP option is selected, network settings will automatically be assigned. To modify inverter settings remotely over Ethernet, use the Installer Setup screen section to gain access. If authorized, MODBUS Ethernet writes over Ethernet will show, "ENABLED".

Network Settings displays the current network settings configuration. **NOTE:** To change network settings remotely, first set the unit's on-board meter (Installer Setup) to allow remote writes over Ethernet. **For security reasons, the, "MODBUS writes over Ethernet" enable/disable setting can only be modified on the local meter display. This a safety feature to prevent unintended changes to custom settings, but it is not a replacement for proper network security. This feature does not block write commands on an EIA-485 network. Never connect units to an open or unprotected network.**

Use the menus to configure:

MODBUS Settings

MODBUS and MODBUS TCP/IP are open standard protocols for communication between connected devices on serial and Ethernet networks respectively. The GenStar MPPT supports Modbus communication via serial (EIA-485/RS-232/USB ports) and Ethernet.

MODBUS ID and MODBUS IP Port - assign IDs as desired

All devices on a serial MODBUS network must have a unique MODBUS ID. All devices on an Ethernet MODBUS network must have a unique ID and common MODBUS IP port configuration.

Bridge Ethernet MODBUS TCP/IP requests with MODBUS Serial Messages

An Ethernet MODBUS TCP/IP message with a MODBUS ID that differs from the GenStar MPPT MODBUS ID will be, "bridged", and sent out as a serial MODBUS message on the GenStar MPPT's EIA-485, RS-232, and USB serial ports (see Figure 2.3 in Section 2.4). A response from a connected device on any of those serial networks will be packaged by the GenStar MPPT and sent as a MODBUS TCP/IP response back to the Ethernet network.

TCP/IPv4

Adjust Ethernet connection parameters.

Time Servers (Installer Setup)

If the GenStar MPPT is connected to the Internet, it has the ability to periodically synchronize time and date from a time server. There are three default, public NTP servers, which users can modify as necessary.

4.2.3 SD Card and Logged Data Storage (Setup and Installer Setup)

The GenStar MPPT includes an **SD Card** for auxiliary data storage. The SD Card screen will display the card status, and total available space. Choose one of the four options for data management: Format SD Card; Delete Log Data; Delete Settings File; Delete Firmware File.

The SD Card menu offers the following information and functions:

SUMMARY

Status:

- The SD card is detected-not detected

Total Storage:

- Total addressable storage of the SD Card

Space Available:

- Remaining space available on the card

Format SD Card:

- Format the SD Card (FAT32). WARNING: erases all contents on the card and creates system directories

Delete Log Data:

- Delete log data files from the /log directory only

Delete Settings File:

- Delete configuration settings files saved in the /settings directory

Delete Firmware File:

- Delete firmware update file(s) in the /update directory

LOGGED DATA STORAGE

Use the Setup or Installer Setup Logged Data Storage drop-down to enable internal logging, or internal and SD Card logging.

There are three different loggers. The daily and hourly Loggers total and record important data once a day and hourly, respectively. The Event Logger records high-speed operational, network, and system-level information.

Choose to log data to the GenStar MPPT internal memory only or also allow log data storage on an SD Card. If the SD card is removed, the GenStar MPPT will continue logging to internal memory only. By selecting, "Internal and SD Card", and using an SD Card, the maximum amount of logged data will be substantially increased.

4.2.4 Load Control (Installer Setup)

By choosing the Standard Button, seven (7) preset load profiles become available. See LiveView Installer Setup\Load for settings options and values within each setting. Use Copy to Custom to start a custom profile using preset values. Load High Voltage Disconnect and Reconnect (HVD and HVR) thresholds can be preset using profiles 5-7. These profiles are useful for batteries that are easily damaged by high voltage.

By choosing the Custom button, the user has full flexibility to enter any desired load control values. Four (4) customized overlays are available to the right of the Custom button:

- 1) Voltage Only - only voltage-related values are adjustable

- 2) State-of-charge (SOC) ONLY - **availability depends on specific Ready Blocks installed**
- 3) State-of-charge (SOC) and Voltage - both SOC and voltage values are adjustable. **Availability depends on system configuration**
- 4) Always On - load terminal voltage is never interrupted-disabled

In custom overlay #3, the user can enter state-of-charge disconnect and reconnect percentages that will disable and enable the load terminal voltage based on battery charge levels. In custom overlays #1 and 3, the user can enter load terminal High Voltage Disconnect and Reconnect (HVD and HVR) values that will disable and enable the load terminal voltage based initially on a user -selected high battery voltage. This setting is useful for batteries that are easily damaged by high voltage.

4.2.5 Charger (Installer Setup)

Also refer to LiveView or meter map for all custom settings options.

Solar Input Mode

MPPT (default) - Allow the controller to use its TrakStar Maximum Power Point Tracking algorithm to determine the optimal solar array voltage operating point.

Fixed Vmp - Disables the MPPT algorithm and uses the specified value as a static source voltage operating point.

Voltage to %VOC - Disables the MPPT algorithm and instead uses a percentage of measured input source open-circuit voltage as the static voltage operating point. Open-circuit voltage (Voc) of the input source is measured by the controller periodically.

Battery Bank Info. Define:

- Battery capacity in Amp-hours. Capacity is used for some charging functions.
- Battery current limit, and whether a Shunt Block is required measurement
- Optional setting to enable a BMS Block for closed-loop battery management
- Optional setting to require an RTS for temperature compensation

Battery Charge Settings



WARNING: Equipment Damage

Improper battery charge settings can severely damage batteries. Take great care when applying any charging settings.

See Section 5.2 for descriptions of many charging settings, and, "Installer Setup", below, for additional variable descriptions.

Define the charging parameters for the battery. Choose a standard charging preset from a range of batteries, OR enter a custom profile if needed. **Copy to Custom** copies the values in the Standard Profile column to the Custom Profile column. Use this feature to start with a standard charging profile that is close to the desired configuration, copy to custom, and then edit the values for a specific charging application.

Preset options are described in Section 5.2.2. Refer to the battery manufacturer's documentation for guidance.

For more standard settings information, and further custom settings adjustment, expand the Installer Setup bar at the bottom of the section.

Battery State-of-Charge (SOC) LED Transitions (also see SOC measurements in Section 4.2.7)

The SOC LED transitions will be based on the selected criterion - an estimation based on battery voltage or SOC percentage in the case of ReadyBMS or ReadyShunt applications.

Enter the battery SOC LED transition voltages or SOC percentages that correspond with the desired LED color or color combination for that voltage or SOC percentage. When there is no SOC percentage value available from a ReadyBMS or a ReadyShunt, the LEDs will display an estimated state-of-charge (SOC) based on the battery voltage.

INSTALLER SETUP SETTINGS

Maximum Regulation Voltage - sets the absolute maximum battery voltage limit. The charger will not charge above this value regardless of charge stage target voltage or temperature compensation effects.

Maximum Equalization Current Limit - sets an absolute limit on the amount of Equalization Stage charging current.

Battery High Voltage Disconnect-Reconnect (HVD-HVR) - set voltages at which charging current ceases (HVD) and then resumes (HVR)

Temperature Compensation Coefficient (mV/°C) - set to adjust the charging set-point to optimize charging for different battery temperatures

Minimum Temperature Compensation Limit - set the lowest temperature at which temperature compensation will occur. Temperature compensation will not occur below this temperature.

Maximum Temperature Compensation Limit - set the highest temperature at which temperature compensation will occur. Temperature compensation will not occur above this temperature.

Low-Temperature Current Foldback (0%, 100%) - low and high temperature settings

The GenStar MPPT has a Low Temperature Foldback option which can be used to protect lithium batteries from being charged in cold conditions. Use this setting to define the bounds of charge current reduction due to low battery temperatures. Configuration can be done in either LiveView or the meter display interface, using the Installer Setup Password 141.

The low temperature-0% limit defines the temperature at which the controller will stop providing battery charging current. The high temperature-100% limit defines the lowest temperature at which the controller will deliver 100% of the controller's rated output charging current. Charging current is tapered linearly from 100-0% between high and low temperature settings

High-Temperature Current Foldback (100%, 0%) - low and high temperature settings

Use this setting to define the bounds of charge current reduction due to high battery temperatures. Using the Installer Setup password, configuration can be done in either LiveView or the meter display interface using the Installer Setup Password 141.

The high temperature-0% limit defines the temperature at which the controller will stop providing battery charging current. The low temperature-100% limit defines the highest temperature at which the controller will deliver 100% of the controller's rated output charging current. Charging current is tapered linearly from 100-0% between low and high temperature settings

Absorption End - Amps - set a net current threshold below which the controller will transition from the Absorption to the Float Stage - see Absorption End Amps Time below.

Absorption End - Amps, Time - set the time required below Absorption End Amps threshold for the controller to transition from the Absorption to the Float Stage.

4.2.6 Schedules (Setup and Installer Setup)

Use the Schedules Page to define schedules for the ReadyRelay function. The Ready Block Section, below, describes various ReadyRelay functions. Note that only External Source Control (ESC) and Command/Schedule functions are schedulable, and require a relay assignment in Ready Block configuration.

For Relay-ESC scheduling, the Schedules Page sets only the Relay-ESC timing for when each of the Custom ESC Start-Stop conditions take effect. Schedules can also be set in the ESC Custom Settings screens, and both are updated when saved. To define ESC Start-Stop conditions, see Section 4.2.8 - External Source Control (ESC) - for ESC Programming details.

4.2.7 ReadyBlocks™ and ReadyShunt SOC Measurements (Installer Setup)

Ready Block Configuration

Installed blocks will populate the Ready Block Configuration Box in the LiveView webpage. The ReadyShunt can also be configured in the local display meter. The location of each block is indicated by positions 1-3, relay A or B for each Relay Block, and shunt A or B for each Shunt Block. Position 1 is the left-most block. Relay A is on the left, and relay B is on the right. Shunt A uses the upper-tier terminals, and Shunt B uses the lower-tier terminals. Choose a block to configure. See ReadyRelay, ReadyShunt and ReadyBMS instructions below.

ReadyRelay (RB-Relay)

The ReadyRelay is an expansion block that adds AC and DC-rated relay dry contact hardware functionality and firmware control and logic to the Morningstar GenStar MPPT charge controller. The ReadyRelay can be used to provide additional load control, external charging source control and other signaling functionality.

IMPORTANT: To enable the use of the Manual or Automatic Source Control Profiles, at least one External Source Control (ESC) control signal must be assigned to a relay (block) -- see Section 4.2.8 on ESC.

Relay Function. Choose how a relay will function: Threshold; Faults and Alarms; Charge Stage; External Source Control (ESC) Start-Stop; Command/Schedule. Each of the two Relay Block relays can be configured for a unique function:

1) **Threshold - no scheduling.** Choose whether the threshold will be reached from a rising (lower) or a falling (higher) value, relative to the threshold; choose a variable, and then enter the desired ON and OFF thresholds, along with desired delays. Activate ReadyRelays using Command buttons (after configuration in LiveView Installer Setup\Ready Block\Relay assignment).

2) **Faults/Alarms - no scheduling.** Programming will activate a relay to control optional devices based on specifically occurring fault conditions:

- A) When charging has stopped due to a fault
- B) When charging has stopped due to high battery voltage

- C) When Load has disconnected due to a fault
- D) When the load has been disconnected due to high battery voltage
- E) An over-temperature alarm has occurred
- F) Charging current is being limited

3) **Charging Stage - no scheduling.** Toggles the relay for use with optional devices when the selected charge period - Bulk, Absorption, Float, Equalization, Night - is active. Optionally, relay start and exit delays can be set.

4) **External Source Control (ESC) Start-Stop.** A) Assign a relay to, "ESC Start-Stop" signal. B) Save and proceed to LiveView\Installer Setup\ESC setup and program accordingly for Manual or Custom. Manual provides ON-OFF Commands only. For Custom Timing Controls and ESC schedules information see Section 4.2.8 External Source Control (ESC). Also see Section, "5.9.5 - ESC Commands".

5) **Command/Schedule.** Provides ON-OFF Scheduling with manual ON-OFF Commands. Only relays that have been configured for "Command/Schedule" function can be controlled by, "Ready Block", Relay Commands.



NOTE: Proper generator/auxiliary equipment relay wiring is required - see ReadyRelay manual for terminal connections diagram.

ReadyShunt (RB-Shunt)

The ReadyShunt is an expansion block designed measure and display net current flow into the battery, or to measure and display source or load auxiliary current.

BATTERY STATE-OF-CHARGE (SOC) REPORTING - viewable in the, "LiveView", tab of the LiveView program, under "Battery Summary"

A ReadyShunt block and external shunt(s) can be used to monitor SOC for reporting, and can enable SOC based load control (see Section 4.2.4 - Load Control - above). When a ReadyBMS is configured during commissioning, it governs all aspects of charging and state-of-charge (SOC) reporting - even with a ReadyShunt installed. Without a ReadyBMS, an installed NET shunt at the battery and a ReadyShunt Block assignment in Installer Setup can enable an SOC sub-system with specific operating parameters - see "Shunt Block Net Shunt Configuration" below for details.

For ReadyShunt installation procedures, refer to the ReadyShunt manual at:

[morningstarcorp.com\support library](http://morningstarcorp.com/support/library).

Shunt Block Net Shunt Configuration for SOC - see ReadyShunt manual p. 16, Figure 5-3 for wiring diagram

After a ReadyShunt is installed:

- 1) Always make sure to update the Firmware to the latest version available (see Section 5.12 Firmware Updates)
- 2) Access the GenStar unit by opening a LiveView web page - see Section 4.1.3.
- 3) Go to Installer Setup\Ready Blocks, and choose the desired Shunt Block.
- 4) Enter "SOC" for the name

- 5) Enter the external shunt full-scale Millivolt and Amp ratings.
- 6) Assign the branch type as "NET". Note that a branch type change will cause a fault, and a system re-boot is required.

DEFINITIONS



NOTES: Currently, voltage and current setpoints, and full SOC duration time are only configurable via Modbus register value assignment.

After any changes to SOC-related value assignments, the controller must be re-booted.

Battery Current - the net battery charging current; the charging current that is measured by the NET battery shunt.

Current Setpoint - the assigned current value that indicates 100% SOC. If an Absorption *End-Amps setting is made in Battery Charging Setup*, it must be less than or equal to the *Current Setpoint* - otherwise, full SOC will not be reported.

CALCULATION: A default of 2% of battery capacity (A-h) equals the current setpoint in Amps. Also see Condition #2 below. **Battery capacity is entered in Installer Setup\Charger\Battery Info.**

Voltage Setpoint - the calculated voltage, based on programmed Absorption voltage, that when exceeded by actual battery voltage, is an indicator of 100% SOC - see Condition #1 below.

FULL SOC DETERMINATION

The battery SOC will be reported at 100% when the two conditions below are true, and after a default cumulative duration of five minutes is reached.

Condition 1 (based on calculated SOC Voltage Setpoint): **Battery voltage is greater than or equal to the Voltage Setpoint**

Condition 2 (based on calculated SOC Current Setpoint): **Battery current is less than or equal to the Current Setpoint**

PARTIAL SOC DETERMINATION

Once full charge has been verified, the GenStar algorithm can then calculate a subsequent existing charge level, and use full capacity to express SOC as a percentage.

SOC PROGRAMMING APPLICATIONS

- 1) SOC LED percentage threshold variables - select SOC percentages to be used for battery SOC LED transitions - see Default SOC LED Percentages Table in Section 5.6.3 Battery State-of-Charge (SOC) LED Transitions.
- 2) Load disconnect-reconnect thresholds - using LiveView, load disconnect and reconnect can be programmed based on a state-of-charge percentage - see Section 4.2.4 Load Control
- 3) Variable for ReadyRelay threshold - an SOC percentage can be used as a variable assigned to trigger a relay for ON-OFF threshold settings.
- 4) Variable for ReadyRelay ESC - an SOC percentage can be used as a variable assigned as a Start or Stop condition for an external source input to the battery bank.

ReadyBMS (RB-BMS)

The ReadyBMS provides simple visibility of battery performance, hands-free settings and optimized battery control. Through the ReadyBMS, the GenStar MPPT will report data variables from the battery BMS. The Block can also interface with lithium batteries for, "closed loop", charging and data reporting.

PYLONTECH LITHIUM BATTERIES - see Warning Notes below

When the GenStar is configured for closed-loop BMS with a PYLONTECH lithium battery, the system will enforce a minimum Load SOC Disconnect of 20 percent, and a minimum Load SOC Reconnect of 25 percent. These minimum LSoCD and LSoCR setpoints are required by PYLONTECH in order to comply with their warranty requirements. This affects the Load Profile setup as follows:

- If a selected preset or custom load profile has the SOC Load Disconnect and Reconnect disabled, the system will automatically set the SOC Load Disconnect to 20 percent and SOC Load Reconnect to 25 percent at boot-up.
- If a selected preset or custom load profile has the SOC Load Disconnect and Reconnect below 20 and 25 percent, respectively, the system will automatically raise the values to 20 and 25 percent, respectively, at boot-up.
- If a selected preset or custom load profile has the SOC Load Disconnect and Reconnect above 20 and 25% respectively, no settings are overridden at boot-up.

WARNING NOTES:

Overridden SOC Disconnect and Reconnect value(s) will be displayed correctly in the local meter and LiveView "Settings" displays. However, when entering the Load Setup menus, it will always display the last saved SOC Disconnect and Reconnect settings, even if those settings were overridden.

If commissioned for "PYLON" closed-loop BMS operation, override warnings will appear in the local display during commissioning, and in LiveView in the Load Setup menu.

4.2.8 External Source Control (ESC) - Installer Setup

IMPORTANT: To enable the use of the Manual or Automatic Source Control Profiles, a ReadyRelay must be programmed for ESC Start/Stop as seen in Section 4.2.7 (above) #4. As of this publication, only one ESC profile can be set up for the system. If multiple relays are set up for ESC Start/Stop they will all share the same ESC settings.

INTRODUCTION

External Source Control (ESC) is an Installer Setup feature that allows the user to program the GenStar MPPT to turn an external charging source on and off in different ways. This may include generators, fuel cells, utility grid etc. Generators are an important auxiliary energy source in many off-grid systems. The main LiveView screen includes two drop-down menus - ESC timing control and ESC Mode. The Timing Controls provide run-time settings, and the ESC Modes determine what schedules and conditions will trigger start and stop control of the ESC relay.

The GenStar can be set up for only one ESC profile, and it is not possible to program multiple ESC profiles for separate relays.

External Source Control Modes Setup Screens

The drop-down menu provides options for Disabled, Manual or Custom Profiles:

1) DISABLED - External Source Control function is disabled

2) MANUAL - External Source start/stop control can be triggered manually via an "ESC" Command or Soft-key. Note that the ESC timing control settings (minimum or maximum run-time and minimum off time) will remain in effect with the manual setting.

Use ESC Commands or Soft-key (see Section 4.2.9) to start or stop an external source manually.

3) CUSTOM - External Source Control can be triggered automatically using Custom ESC settings for an ESC Start-Stop assigned relay. When Custom Mode is chosen, a Custom ESC setup screen with four (4) scheduling-control criteria options will appear below. It is also possible to select factory defaults. Choose a desired scheduling option by hovering/highlighting and clicking on one of the four lines.

- Select a preset control criteria option.
- Select customized control criteria, and values, as desired.

Once a ReadyRelay has been designated as External Source control signal, ESC can be used to start or stop the external source automatically. Enter timing in Installer Setup\Schedule\Start Charging 1, 2 or 3, for example, or go to Installer Set-up\ESC\Modes\Custom.

Multiple ESC Start - Stop conditions can be programmed each with its own schedule. These control functions are listed here in the order of precedence:

- 1) Prohibit - no criteria/conditions, overrides all other settings
- 2) Emergency - set criteria in External Source Control (ESC)
- 3) Pause - defines the hours of the day during which charging can be paused. Define criteria that, if true, will pause charging during these hours.
- 4) External Source Control (ESC) Start Charging 1, 2, 3

ESC PROGRAMMING

Opening ESC Screen:

The ESC signals will populate based on ReadyRelay assignments to control ESC. The opening ESC screen displays drop-down menus for ESC timing controls, mode and schedules (Custom Mode).

The left column in Figure 4-2 below, lists the *ESC Timing Controls* that can be set for the operation of an External Source Control input. *Minimum Time Off* sets a requirement of time elapsed from turning off, before the external source can start again. *Minimum Run-time* sets the least duration the external source can run. *Maximum Run-time* sets the greatest duration the external source can run. Each setting in the programmed timing control sequence will be checked and satisfied before the external source will start or stop.



CAUTION:

For the relays to allow Generator operation, maximum run-time (ESC\Timing Controls) is disabled by default. Ensure the Maximum Run Time (if enabled) is long enough to meet or exceed any scheduled duration.

The following schedules - in order of precedence - are available in Installer Setup\ESC:

- 1) Prohibit - no criteria/conditions, overrides all other schedules
- 2) Emergency - set criteria in External Source Control (ESC) schedules
- 3) Pause - defines the hours of the day during which charging can be paused. Define criteria that, if true, will pause charging during these hours.
- 4) External Source Control (ESC) Start Charging 1, 2, 3

EXTERNAL SOURCE CONTROLS TIMING SEQUENCE EXAMPLE (Intervals are met when elapsed time equals required time)

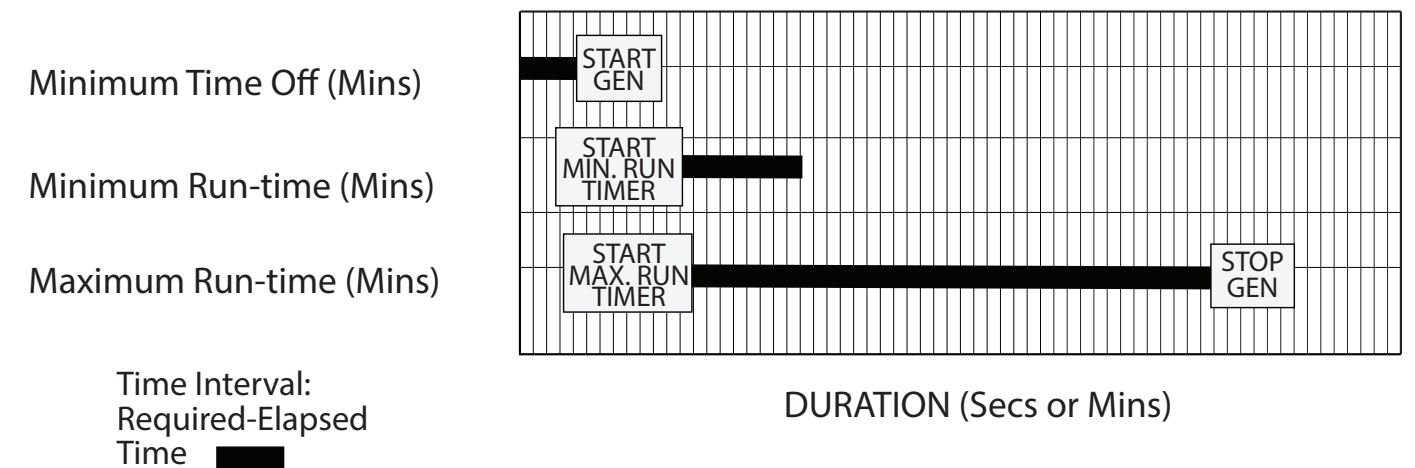

Figure 4-2. External Source Control Timing

ESC Schedules (timing entered in Setup OR Installer\Schedules)

Use the *Schedules* menu or Custom ESC Cards to specify a schedule to be implemented. Each schedule's details come from the settings made in the *Schedules* Sections.

By specifying various schedules, a broad schedule structure can be achieved. Each schedule's control criteria comes from conditions entered in Emergency Charging, Start Charging (1, 2, and 3), Pause Charging, or Prohibit Charging Screens.

Conditions - General

Define conditions for each schedule. Multiple conditions, and up to two groups of conditions can be assigned to control the relay.

After schedules have been defined, add conditions or groups of conditions, and combine logically with, "any" (OR), or, "all" (AND), syntax, if desired. There can be up to four conditions per schedule defined in up to two groups. The logical combination of conditions and groups comprises the governing criteria.

The time delay is the duration between a condition being met, and the control action occurring (if more than one condition, the longest delay will apply). The main purpose of the time delay, is to have some certainty that conditions are not just temporary, and will not, "falsely", trigger the control.

GenStar MPPT summary lines for Start and Stop conditions appear after each condition or group. The lines will textually describe the control conditions.

The Start and Stop conditions reside within a given schedule. If a schedule is activated because a Start condition is met, the operation will only cease if, and when, the paired Stop condition is met.

ESC Schedules and Conditions - Installer Setup\ESC\Modes\Custom



NOTE:

Pause will override the Start Charging 1, 2 and 3 schedules. User-defined criteria / conditions will determine if the external source is actually shut off/paused during a Pause Charging Schedule.

DEFINE SCHEDULES FOR:

Prohibit Operation - a valid schedule will override Emergency Charging

Use Prohibit Operation to prevent the charging source from ever running automatically - no conditions are programmable

Emergency Charging - fixed setting, no schedule settings

Use to start charging in order to prevent a user-defined "emergency" condition. The factory default condition is to start when there is an LVD Warning.

Start Charging (Charging 1,2 and 3)

Use Start and Stop Charging hours to define conditions when the charging source will charge the batteries. The factory default condition (Charging 1) is to start when there is a low battery voltage and duration. Conditions can be customized.

Pause Charging

Use Pause Charging to define conditions when charging operation will be interrupted or resumed. There are no default conditions, but custom conditions can be added.

Start Charging (Charging 1,2 and 3)

Use Start and Stop Charging hours to define conditions when the charging source will charge the batteries. Default condition is a battery voltage and duration defined by user. Conditions can be customized.

ESC START-STOP SCHEDULE PRESET DROP-DOWN OPTIONS

On Schedule (available in Pause, Prohibit, and Start Charging 1, 2, 3)

Conditions needn't be added for this setting. It sets the criteria to always TRUE, so the ESC schedule is always TRUE during the user-defined scheduled hours. Custom Start and/or Stop criteria can also be set to govern On Schedule timing - see, "Defining Conditions and Groups", below, for details.

Emergency Charging Presets:

- Avoid LVD
- Low Battery voltage

Pause Charging

- On Schedule timing or custom programming

Prohibit Charging

- ONLY On Schedule timing

Start Charging (Charging 1,2 and 3)

Presets include:

- On Schedule timing
- Low Battery / Bulk
- Low SOC / Bulk
- Large DC Load / Reduced DC Load

DEFINING CONDITIONS and GROUPS

A **Wrench Icon** means customize conditions or toggle to view more scheduling routines.

The Start and Stop conditions are set within ESC scheduling. If a schedule is activated because a Start condition is met, the operation will only cease if and when the paired Stop condition is met.

Four different types of conditions can be used: Simple Condition, Variable Comparison, Range Condition, Event. Each condition type is populated with a default variable, and offers a drop-down list of optional variables for customization.

Simple Condition

Specify a delay after which the external source will START or STOP when a chosen variable meets a chosen relational comparison with a chosen threshold value

Variable Comparison

Specify a delay after which when the external source will START or STOP when two chosen variables meet a chosen relational comparison

Range Condition

Specify a delay after which when the external source will START or STOP when a chosen variable is within a range of specified values

Event

Specify a delay after which the external source will START or STOP when a chosen event has occurred.



WARNING: To prevent overcharging of the battery or unintended run-time of the charging source, ESC Stop Condition Settings should be considered very carefully. For example, if an Event Stop setting is set to Stop charging when Charge Stage Absorption occurs, it will only be triggered after the GenStar solar controller has reached the Absorption Charge Stage and will not be triggered during Bulk, Night or Solar Controller Fault.

ESC SETUP SEQUENCE

Figure 4.3 below shows the process of ESC programming.

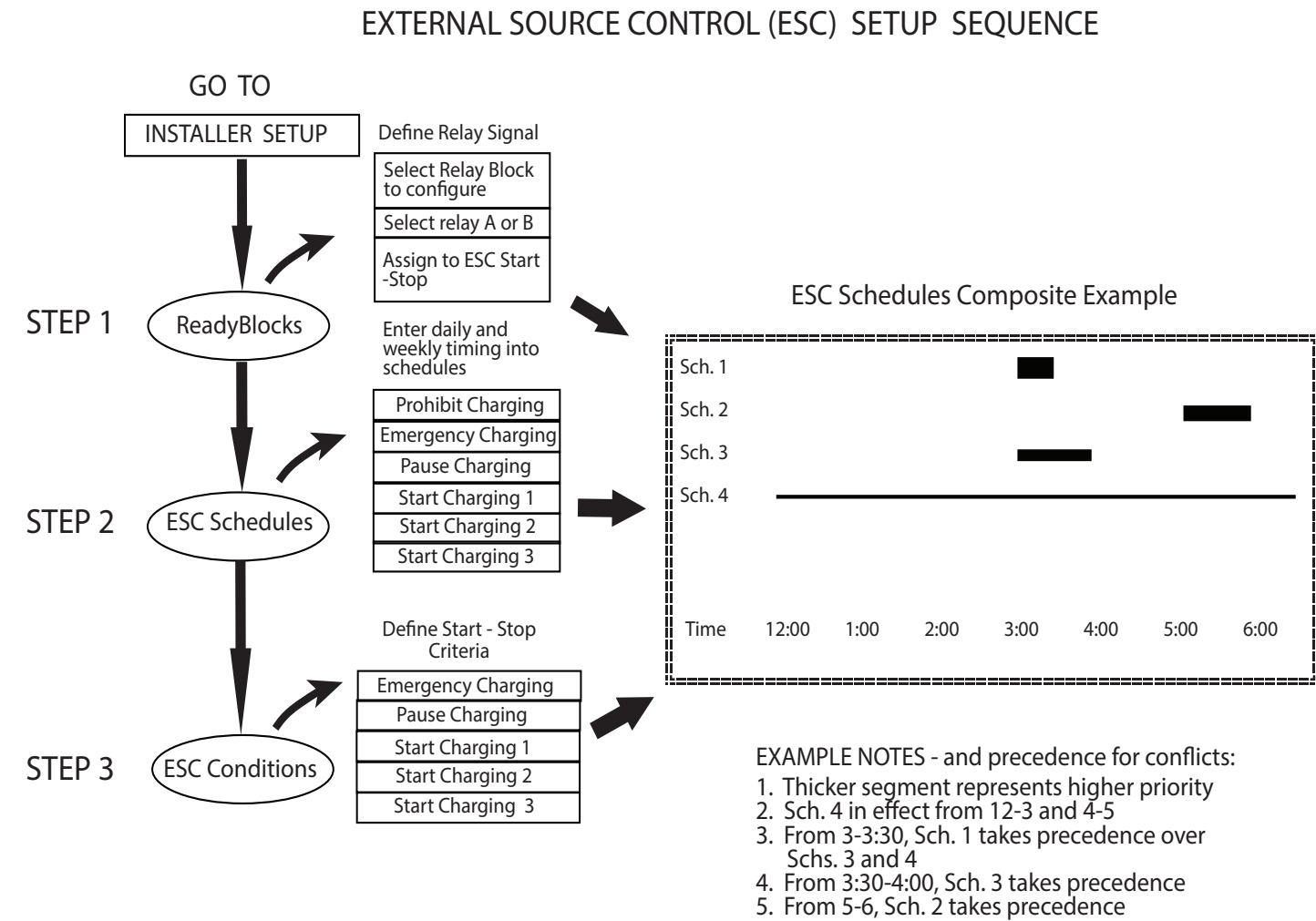

Figure 4-3. External Source Control Setup Sequence

4.2.9 Local Meter Display and Button (Setup and Installer Setup)

The **Meter Display** can be used to:

- 1) Adjust screen appearance and functionality - see Figure 4-1, Display and Button Branch for details.
- 2) Map-program **Soft-key** commands for momentary press and press and hold -- hold time is >2 seconds.

4.2.10 Save and Load (Setup and Installer Setup)

To **Save** settings to a PC or an SD Card, enter a filename and use the Save button for the preferred location. **Load** settings from a PC or an SD Card by choosing a file and then clicking on the Load button. Use the View button to review a summary of the file settings before loading.

5.0 OPERATION

5.1 TrakStar™ MPPT Technology and Charging

The GenStar MPPT utilizes Morningstar's TrakStar Maximum Power Point Tracking technology to extract maximum power from the solar module(s). The tracking algorithm is fully automatic and does not require user adjustment. Trakstar technology will track the array maximum power point voltage (V_{mp}) as it varies with weather conditions, ensuring that maximum power is harvested from the array through the course of the day.

Current Boost:

In many cases, TrakStar MPPT technology will "boost" the solar charge current. For example, a system may have 2 amps of solar current flowing into the GenStar MPPT and five amps of charge current flowing out to the battery. The GenStar MPPT does not create current! Rest assured that the power into the GenStar MPPT is the same as the power out of the GenStar MPPT. Since power is the product of voltage and current (Volts x Amps), the following is true*:

- (1) Power Into the GenStar MPPT = Power Out of the GenStar MPPT
- (2) Volts In x Amps In = Volts Out x Amps Out

* assuming 100% efficiency i.e. if no losses in wiring and conversion existed.

If the solar module's V_{mp} is greater than the battery voltage, it follows that the battery current must be proportionally greater than the solar input current so that input and output power are balanced. The greater the difference between the maximum power voltage and battery voltage, the greater the current boost. Current boost can be substantial in systems where the solar array is of a higher nominal voltage than the battery as described in the next section.

High Voltage Strings and Grid-tie Modules

Another benefit of TrakStar MPPT technology is the ability to charge 12 or 24 volt batteries with solar arrays of higher nominal voltages. A 12 volt battery bank can be charged with a 12, 24, 36 or 48V nominal off-grid solar array. Certain grid-tie solar modules may also be used as long as the solar array open circuit voltage (V_{oc}) rating will not exceed the GenStar MPPT 200V maximum input voltage rating at worst-case (lowest) module temperature. The solar module documentation should provide V_{oc} vs. temperature data.

Higher solar input voltage results in lower solar input current for a given input power. High voltage solar input strings allow for smaller gauge solar wiring. This is especially helpful for systems with long wiring runs between the solar array and the GenStar MPPT.

An Advantage Over Traditional Controllers

Traditional controllers connect the solar module directly to the battery when recharging. This requires that the solar module operate in a voltage range that is below the module's V_{mp} . In a 12V system, for example, the battery voltage may range from 10 - 15 Vdc but the module's V_{mp} is typically around 17V. Figure 5.1 - below - shows a typical current vs. voltage output curve for a nominal 12V off-grid module.

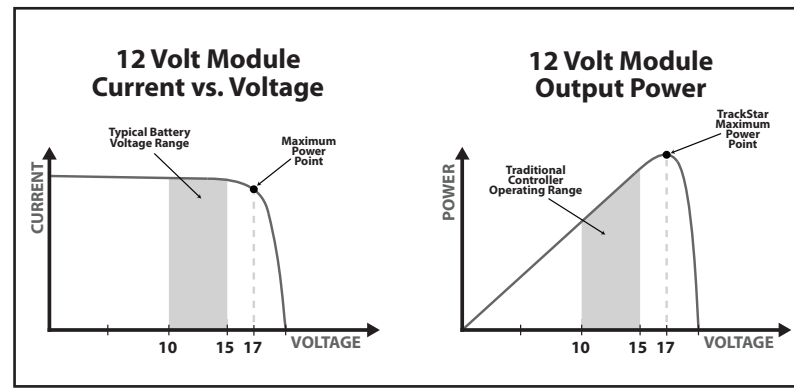

Figure 5.1. Nominal 12 volt solar module I-V curve and output power graph

5.2 GenStar MPPT Charging

The GenStar MPPT system batteries will have different charging requirements based on application, mode of operation, season, usage schedules, load profile, etc. The GenStar MPPT's charging algorithms and settings have the capability to provide optimal charging, with flexibility for very specific demands. The charger also offers easy to use preset profiles that will facilitate good battery health.

5.2.1 Charging Algorithms

Charging is completely adjustable to accommodate a variety of battery chemistries. The GenStar MPPT offers a 4-stage battery charging algorithm for rapid, efficient, and safe battery charging. Figure 5-2, below, shows the sequence of stages. The first charging phase is the *Battery Recharge Cycle* that includes the Bulk, Absorption, Float, and Equalization stages. This cycle typically takes several hours to complete.

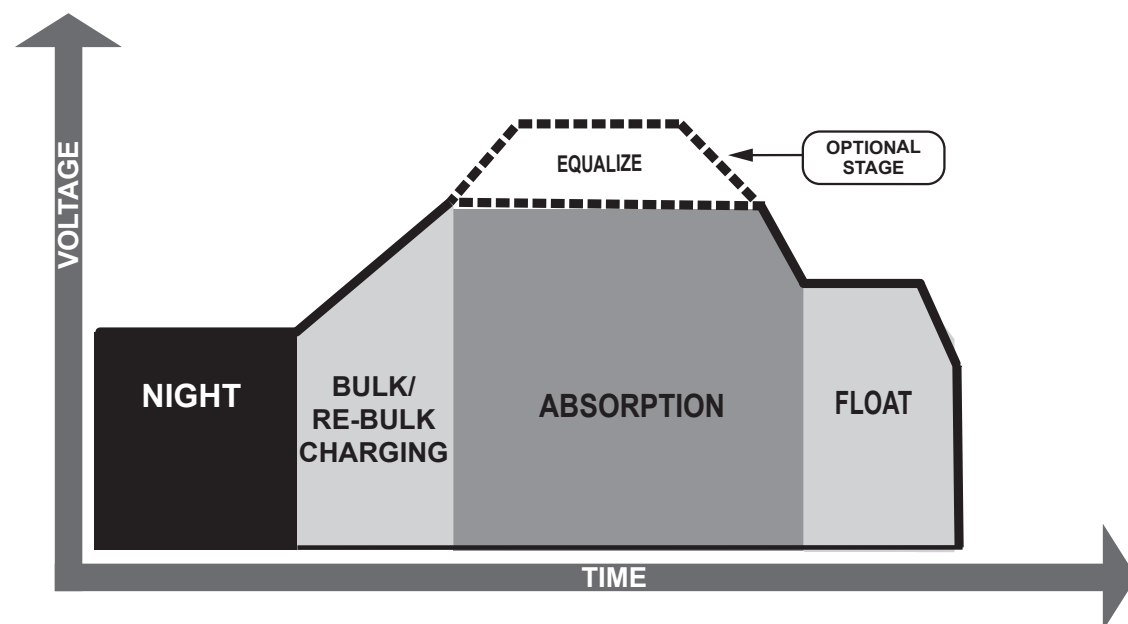

Figure 5-2. GenStar MPPT 4-stage charging algorithm

5.2.2 Charging Profiles

GenStar MPPT offers eight (8) preset battery charging profiles, as seen in Tables 5-1 below. These standard charging settings are suitable for lead-acid batteries ranging from sealed (gel, AGM, maintenance-free) to Flooded and Lithium cells. All voltage settings listed are for nominal 12 Volt batteries. Multiply the voltage settings by two (2) or (4), for 24 and 48 Volt systems, respectively.

NOTE: These settings are general guidelines for use at the operator's discretion. The GenStar MPPT can also be custom programmed to satisfy a wide range of charging parameters. Consult the battery manufacturer for optimal battery charge settings.

Table 5-2 shows all preset high voltage disconnect and reconnect settings. Table 5-3 shows the shared settings that are common to all GenStar charging presets. Table 5-4 is a list of preset LVD-LVR (Load Control disconnect-reconnect) profiles that also shows current compensation values. Any Load Control preset can be added to a battery charging profile.

GenStar MPPT Preset Charging Profiles (@ 25°C)

Battery Type-Preset	Absorption Voltage	Float Voltage	Equalization Voltage	Absorption Time	Equalization Time	Equalization Timeout
	Volts	Volts	Volts	Minutes	Minutes	Minutes
1 - Sealed	14.1	13.7	Disabled	150	Disabled	Disabled
2 - Sealed	14.3	13.7	14.6 ¹	150	60	120
3 - Sealed / Flooded	14.5	13.6	15.0 ¹	180	60	120
4 - Sealed / Flooded	14.6	13.5	15.2 ¹	180	120	180
5 - Sealed / Flooded	14.8	13.5	15.4 ¹	180	120	180
6 - LiFePO4 - Low ²	13.6	13.5	Disabled	180	Disabled	Disabled
7 - LiFePO4 - Medium ²	13.9	13.5	Disabled	20	Disabled	Disabled
8 - LiFePO4 High ²	14.2	13.5	Disabled	15	Disabled	Disabled

CHARGING PRESET NOTES:

¹ For Presets 2-5, an equalization charging stage can be initiated manually using the Start Equalization Command from the local meter or LiveView. The auto equalization interval can only be set up using custom settings.

² CAUTION: LiFePO4 settings are for 4, 8 and 16-cell LiFePO4 batteries only.

- Preset temperature compensation co-efficient for sealed or flooded batteries = -30 Millivolts / °C / 12V -- temp. comp. is disabled for LiFePO4 presets.

- All settings, including charging stage voltages and timing, can be custom programmed using the local meter or LiveView. LiveView includes additional advanced custom programming options.

- CAUTION: Equipment Damage

Do not equalize sealed batteries with preset or custom settings unless recommended by the battery manufacturer. To prevent the possibility of unintended equalization, use custom settings to disable all equalization.

- CAUTION: Settings may not be compatible with all models of these battery types.

- All voltage setting values are for 12V systems. Multiply values by two (2) for 24 Volt batteries, or by four (4) for 48 Volt systems.

Table 5-1. GenStar MPPT Preset Charging Settings

GenStar MPPT Load HVD-HVR Preset Charging Settings

Battery Type-Preset	Load HVD	Load HVR
	Volts	Volts
1 - Lead-acid	Disabled	Disabled
2 - Lead-acid	Disabled	Disabled
3 - Lead-acid	Disabled	Disabled
4 - Lead-acid	Disabled	Disabled
5 - LiFePO4 - Low	14.8	13.8
6 - LiFePO4 - Medium	14.8	13.8
7 - LiFePO4 High	14.8	13.8

Table 5-2. GenStar MPPT HVD-HVR Preset Charging Settings

GenStar MPPT Shared Settings

Shared Setting	Lead-Acid Value	Lithium Value	Units
Absorption Extension Voltage	12.5	Disabled	Volts
Absorption Extension Time	Absorption Time + 30	NA	Minutes
Float Exit Time-out Voltage	12.6	13.3	Volts
Float Exit Time-out	60	60	Minutes
Float Cancel Voltage	12.0	Disabled	Volts
Equalize Time-out	Equalize Time +60 ¹	NA	Minutes
Temperature Compensation Co-efficient	-30	Disabled	Millivolts/°C/ 12V
Compensation Temperature Range	- 20 to +40	NA	°C
Low Temperature Folback 100%	Disabled	+2	°C
Low Temperature Folback 0%	Disabled	0	°C

¹ If equalization is enabled

Table 5-3. GenStar MPPT Shared Preset Charging Settings

GenStar MPPT LVD-LVR (Load Control) and Current Compensation Profiles

Load Control Type-Preset	LVD	LVR	LVD Warning	Current Comp.
	Volts	Volts	Minutes	mV/A
1 - Lead Acid	11.10	12.60	10	0
2 - Lead Acid	11.50	12.80	10	-4
3 - Lead Acid	11.70	12.90	20	-6
4 - Lead Acid	12.00	13.20	20	-6
5 - Lithium LiFePO4	12.50	13.15	1	0
6 - Lithium LiFePO4	12.70	13.25	2	-1
7 - Lithium LiFePO4	12.85	13.30	5	-2

Table 5-4. GenStar MPPT Preset LVD-LVR and Current Compensation Profiles

5.2.3 Bulk Charging Stage

During Bulk charging, the battery is not at 100% state of charge and battery voltage has not yet charged to the Absorption voltage set-point. The controller will deliver 100% of available solar power to recharge the battery.

5.2.4 Absorption Stage

When the battery has recharged to the Absorption voltage set-point, constant-voltage regulation is used to maintain battery voltage at the Absorption set-point. This prevents heating and excessive battery gassing. The battery is allowed to come to full state of charge at the Absorption voltage set-point. The green SOC LED will blink once per second during Absorption charging. The battery must remain in the Absorption charging stage for a cumulative 150-180 minutes, depending on battery type, before transition to the Float stage will occur. However, Absorption time will be extended by 30 minutes if the battery discharges below 12.50 volts (12V system) the previous night.

The Absorption set-point is temperature compensated through either the on-board local temperature sensor, or an optional Remote Temperature Sensor (RTS), if connected.

5.2.5 Float Stage

After the battery is fully charged in the Absorption stage, the GenStar MPPT reduces the battery voltage to the Float voltage set-point. When the battery is fully recharged, there can be no more chemical reactions and all the charging current is turned into heat and gassing. The float stage provides a very low rate of maintenance charging while reducing the heating and gassing of a fully charged battery. The purpose of float is to protect the battery from long-term overcharge. The green SOC LED will blink once every two (2) seconds during Float charging.

Once in Float stage, loads can continue to draw power from the battery. In the event that the system load(s) exceed the solar charge current, the controller will no longer be able to maintain the battery at the Float set-point. Should the battery voltage remain below the Float set-point for a cumulative sixty minute period, the controller will exit Float stage and return to Bulk charging.

The Float set-point is temperature compensated through the included Remote Temperature Sensor (RTS), if connected.

5.2.6 Equalization Stage



WARNING: Risk of Explosion
Equalizing vented batteries produces explosive gases. The battery bank must be properly ventilated.



CAUTION: Equipment Damage
Equalization increases the battery voltage to levels that may damage sensitive DC loads. Verify all system loads are rated for the temperature compensated Equalize voltage before beginning an Equalization charge.



CAUTION: Equipment Damage
Excessive overcharging and gassing too vigorously can damage the battery plates and cause shedding of active material from the plates. An equalization that is too high or for too long can be damaging. Review the requirements for the particular battery being used in your system.

Certain batteries benefit from a periodic boost charge to stir the electrolyte, level the cell voltages, and complete the chemical reactions. Equalization (EQ) charging raises the battery voltage above the standard absorption voltage so that the electrolyte gases. The green SOC LED will blink rapidly two (2) times per second during equalization charging. The duration of the equalize charge is determined by the selected battery type. See table 5-1 in this section for more details. The *Equalization Time* is defined as time spent at the equalization set-point. If there is insufficient charge current to reach the equalization voltage, the EQ will terminate after an additional 60 minutes to avoid over gassing or heating of the battery. The GenStar MPPT meter, or LiveView, can also be used to set EQ voltage and duration.

The Equalization set-point is temperature compensated with use of the included Remote Temperature Sensor (RTS), if connected.

Why Equalize?

Routine equalization cycles are often vital to the performance and life of a battery - particularly in a solar system. During battery discharge, sulfuric acid is consumed and soft lead sulfate crystals form on the plates. If the battery remains in a partially discharged condition, the soft crystals will turn into hard crystals over time. This process, called, "lead sulfation", causes the crystals to become harder over time and more difficult to convert back to soft active materials. Sulfation from chronic undercharging of the battery is the leading cause of battery failures in solar systems. In addition to reducing the battery capacity, sulfate build-up is the most common cause of buckling plates and cracked grids. Deep cycle batteries are particularly susceptible to lead sulfation.

Normal charging of the battery can convert the sulfate back to the soft active material if the battery is fully recharged. However, a solar battery is seldom completely recharged, so the soft lead sulfate crystals harden over a period of time. Only a long controlled overcharge, or equalization, at a higher voltage can reverse the hardening of sulfate crystals.

When to Equalize?

The ideal frequency of equalizations depends on the battery type (lead-calcium, lead-antimony, etc.), the depth of discharging, battery age, temperature, and other factors. One very broad guide is to equalize flooded batteries every 1 to 3 months or every 5 to 10 deep discharges. Some batteries, such as the L-16 group, will need more frequent equalizations.

The difference between the highest cell and lowest cell in a battery can also indicate the need for an equalization. Either the specific gravity or the cell voltage can be measured. The battery manufacturer can recommend the specific gravity or voltage values for your particular battery.

Preparation for Equalization

First, confirm that all of the system loads are rated for the equalization voltage. Disconnect any loads at risk of damage due to the high input voltage.

If Hydrocaps are used, be sure to remove them before starting an equalization. Replace the Hydrocaps with standard battery cell caps. The Hydrocaps can get very hot during an equalization. After the equalization is finished, add distilled water to each cell to replace gassing losses. Check that the battery plates are covered.

Equalize a Sealed Battery?

The GenStar MPPT Preset Charging Settings (Table 5-1 in this section) includes one sealed battery charging profile with an Equalization Voltage Column. This is a minimal, "boost", cycle to level individual cells. This is not a true equalization, and will not vent gas from sealed batteries that require up to 14.6V equalization charging (12V battery).

The GenStar MPPT Preset Charging Settings also includes three Sealed/ Flooded battery profiles which can be used with sealed batteries that have a charging requirement of 14.5-14.8V (12V battery). However, these equalization voltage settings are intended strictly for flooded batteries only. Sealed batteries must never be equalized when using these profiles.

5.2.7 Charging Variables

Each charging variables in this section is graphically illustrated with examples below:

Absorption Extension Threshold

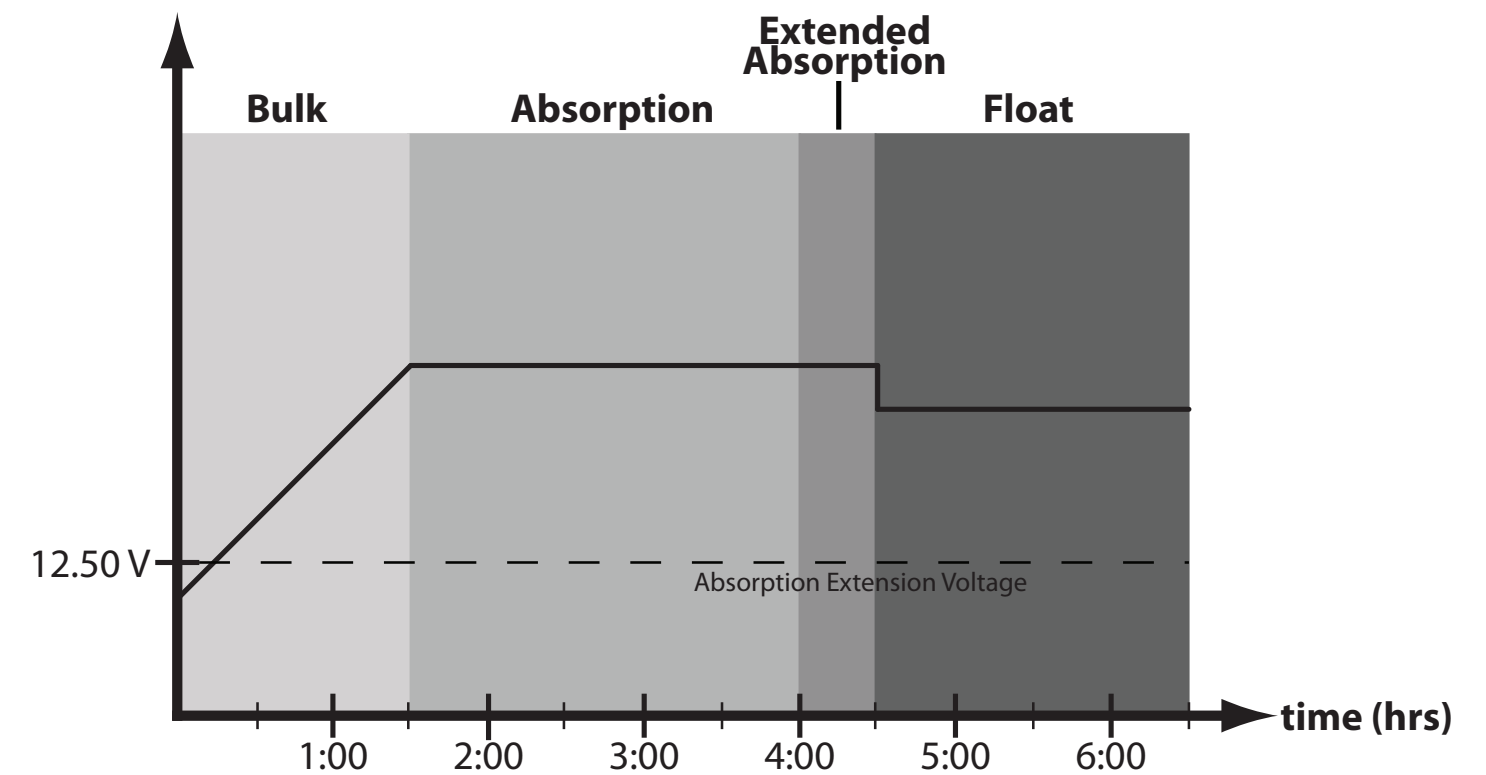

Figure 5-3. Absorption Extension Charging Profile

If battery voltage discharges below the Absorption Extension Threshold the previous night, Absorption charging will be extended on the next charge cycle as shown in the example in Figure 5-3 above.

The voltage threshold and extension time depend on the chosen standard profile or custom settings.

Float Exit Time-out Voltage Threshold

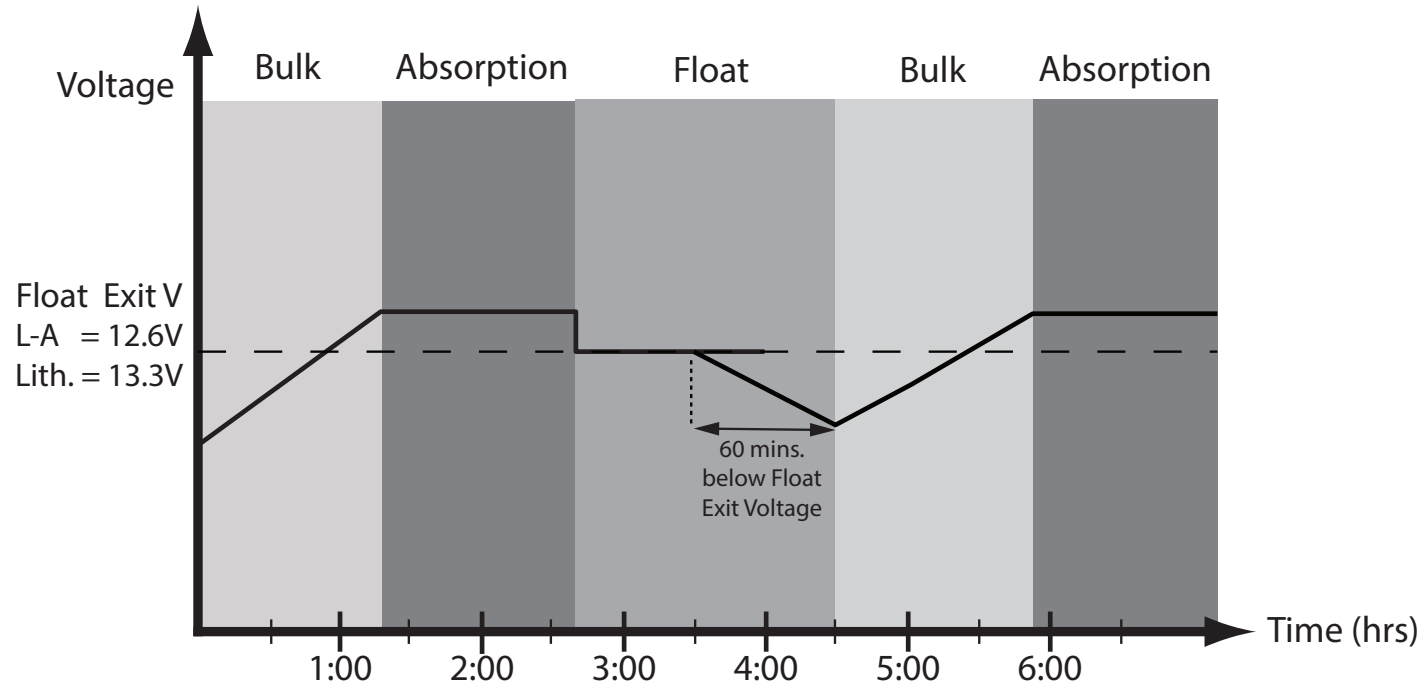

Figure 5-4. Float Exit Time-out Voltage Charging Profile

Preset Charging Profiles

After entering Float stage, the controller will only exit Float if the battery voltage remains below *Float Exit Time-out Voltage* for sixty cumulative minutes. In Figure 5-4 above, a system load turns on at 3:30 hrs when the controller is in Float stage, runs for one hour, and turns off at 4:30 hrs. The load current draw is larger than the charge current, causing battery voltage to drop below the shared *Float Exit Time-out Voltage* of 12.6 for lead-acid, or 13.3 for Lithium, for sixty minutes. After the load runs for sixty minutes, the time-out causes the controller to return to Bulk charging, and then Absorption stage again. In this example, a load runs continuously for sixty min. However, because the Float exit timer is cumulative, multiple momentary load events that pull the battery voltage below Float voltage for a combined sixty minutes duration, will also force an exit from the Float stage.

Custom Charging

The float exit time-out and voltage can also be custom programmed.

Float Cancel Voltage

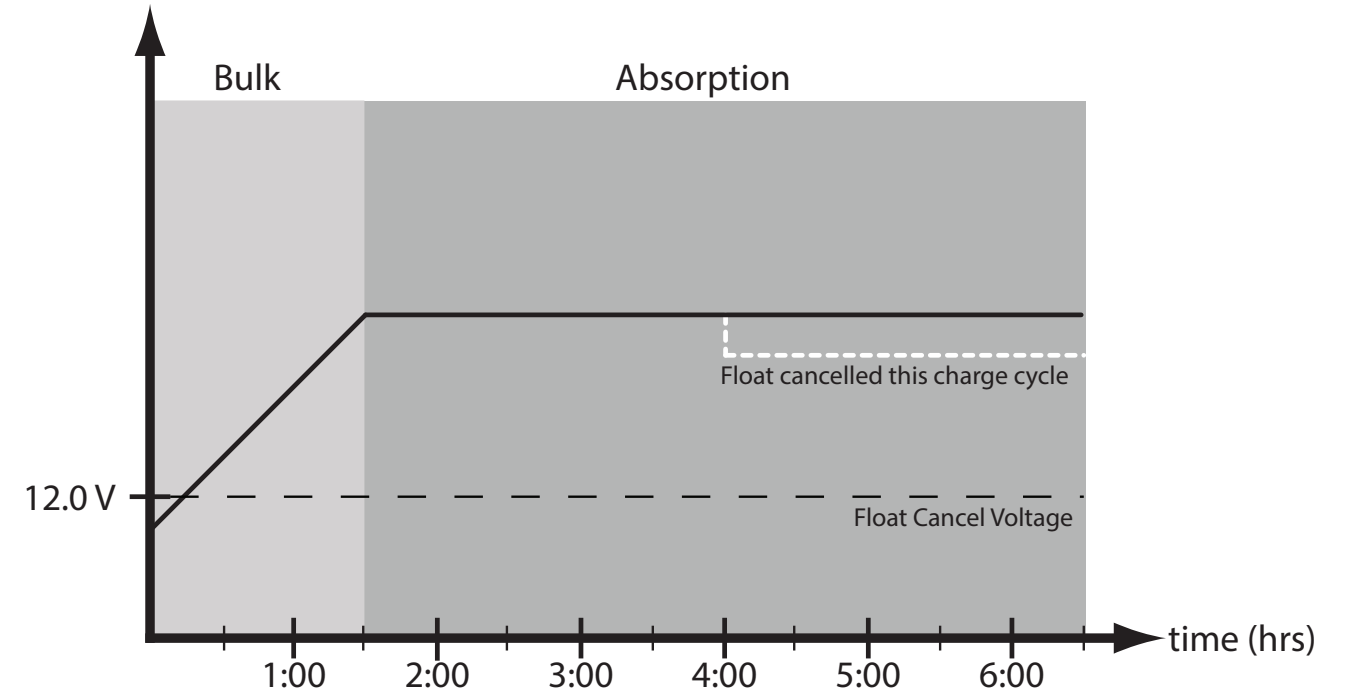

Figure 5.5. Float Cancel Charging Profile

For Lead-acid presets, the battery bank discharges below 12.0 volts (24.0 volts @ 24 V) the previous night, Float charging stage will be cancelled for the next charge cycle. Figure 5-5 above, illustrates this concept. At 0:00 hrs (dawn), battery voltage is below the Float Cancel threshold voltage. The diagram shows where Float stage would have occurred if Float was not canceled. **Float cancel voltage is disabled for Lithium presets (6-8).**

Equalization Time-out

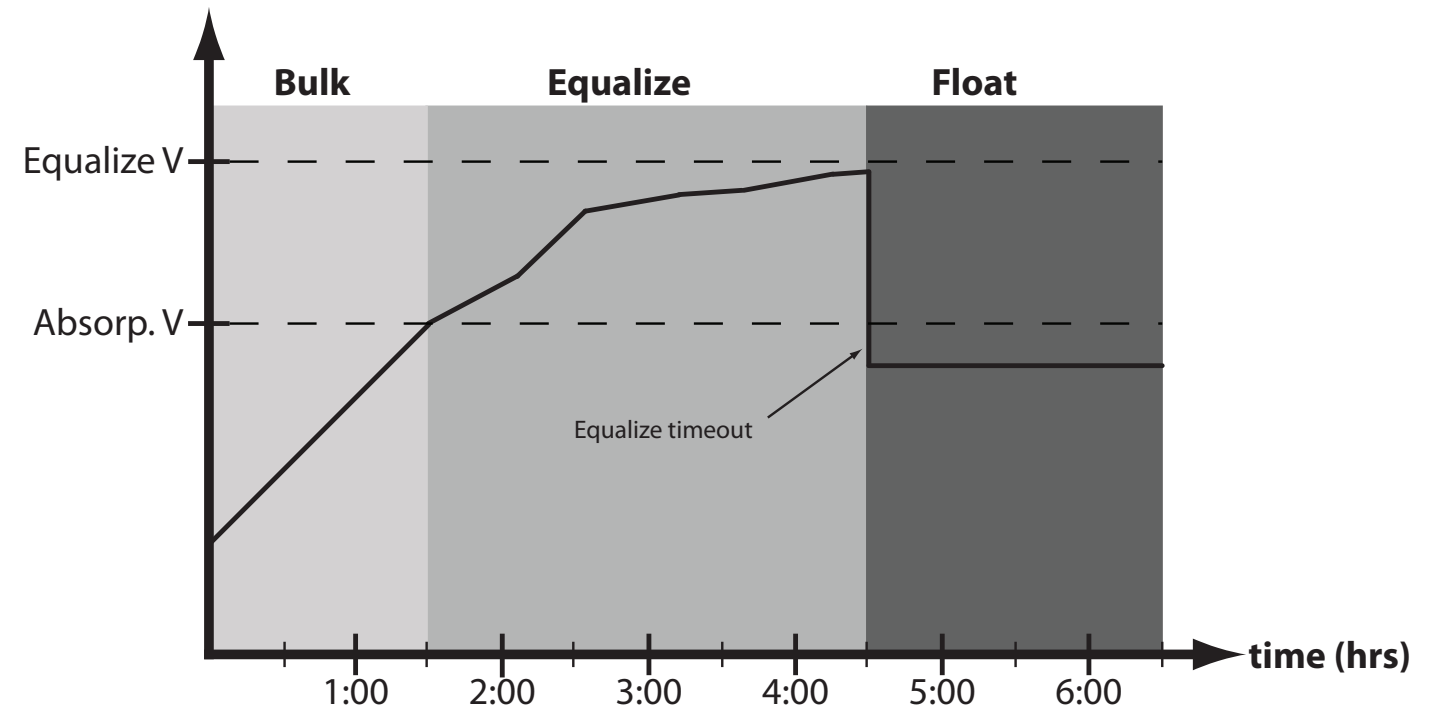



Figure 5.6. Equalize Time-out Charging Profile

The charging profile in figure 5-6 above, shows an *Equalization Time-out* event. The time-out timer begins as soon as battery voltage exceeds the Absorption voltage set-point. If there is insufficient charging current or system loads are too large, the battery voltage may not reach the Equalization set-point. Equalization Time-out is a safety feature that prevents high battery voltage for extended periods of time which may damage the battery. Equalization time-out duration depends on the chosen preset, and is also customizable. **Equalization Time-out is disabled for Lithium presets (6-8).**

5.3 Load Control Information

The primary purpose of the load control function is to disconnect system loads when the battery has discharged to a low state of charge, and to reconnect system loads when the battery is sufficiently recharged. System loads may be lights, DC appliances, or other electronic devices. The total current draw of all loads must not exceed the GenStar 30 Amp maximum load rating.

 **CAUTION: Equipment Damage**
Do not wire any AC inverter to the load terminals of the GenStar. Damage to the load control circuit may result. An inverter should be wired to the battery. If there is a possibility that any other load will sometimes exceed the GenStar's maximum voltage or current limits, the device should be wired directly to the battery or battery bank. If load control is required, contact Morningstar Tech Support for assistance.

Current Compensation

Each load control profile specifies its own current compensation - some being zero. Under load, the battery voltage will sag in proportion to the current draw of the load. Without a current compensation feature, a short-term large load could cause a premature LVD. LVD-LVR - Load Control Profiles - are adjusted lower per the preset Table 5-4 in Section 5.2.2, or as customized programmed.

LVD Warning

As the battery discharges, the Battery Status LEDs will transition from green to yellow and then from yellow to flashing red. The flashing red indication is a warning that a low voltage disconnect (LVD) event will occur soon.

The amount of time between a green SOC indication and load disconnect will depend on many factors including:

- rate of discharge (amount of load draw)
- capacity of the battery
- health of the battery
- LVD set-point

If the battery discharges to the LVD set-point the load will disconnect and a solid red Battery Status LED indication will be displayed.

General Load Control Notes

Do not wire multiple GenStar MPPT load outputs together in parallel to power DC loads with a current draw greater 30 Amps. Equal current sharing cannot be assured and an over-load condition will likely occur with one or more controllers.

Exercise caution when connecting loads with specific polarity before energizing a load circuit. A reverse polarity connection may damage the load. Always double check load connections before applying power.

5.4 Soft-key Use

The GenStar MPPT features a push-button that operates as follows:

Programmable Soft-key (maps command functions)

The Soft-key button is located at the lower left corner of the meter interface. The button can be programmed to control up to two commands - one command with a momentary press, and another with a prolonged (>2 sESC) press. Soft-key commands are assigned in the Display and Button Menu of the local meter display, and the Meter Display Page in LiveView.

5.5 Factory Reset Procedure

Factory Reset must be done using the on-board meter display. Navigate to Setup\Advanced Setup\Installer Setup, and enter Installer Password 141. Then navigate to Commands\Factory Reset and choose that option. After a factory reset, the unit will need to be re-commissioned.

 **CAUTION:** Before performing a factory reset, be sure to save the settings configuration to an SD card. The meter display can only save ALL settings to an SD card, by creating a system image. A system image is a copy of all settings, including commissioning settings. The complete system image configuration can then be quickly loaded whenever needed.

 **WARNING: Risk of Explosion**
When loading a system image configuration from an SD Card, ensure that the destination device has the same system voltage, battery profile, and RTS; otherwise, there is a potential risk of system damage or bodily injury.

5.6 LED Indications (see Figure 2-2)

The GenStar MPPT meter face houses one Status LEDs (left of screen) and a set of three battery State-of-Charge LEDs (beneath screen - horizontal).

LED Display Key

G = green LED is lit

Y - R = yellow LED is lit, then red LED is lit

G / Y = Green and Yellow are both lit at the same time

G / Y - R = Green & Yellow both lit, then Red is lit alone

Sequencing LED patterns (faults) repeat until the fault is cleared

5.6.1 General LED Indications

The Green, Yellow or Red State-of-Charge LEDs are used for general indications and charging indications.

General Indications

- | | |
|--------------------------------|--|
| • Start-up | G for (3) sESC, then G - Y - R |
| • Start-up - failed bootloader | G / Y / R for (3) sESC, then G, then STOP on Y |
| • Reset to factory settings | ALL LEDs (3) times, then R-Y-G |

5.6.2 Battery Charging LED Indications

- Equalize start request G / Y / R - G / Y / R - G - G
- Equalize cancel request G / Y / R - G / Y / R - R - R
- Equalization stage G flashing (2 per sec)
- Absorption stage G flashing (1 per sec)
- Float stage G flashing (1 per 2 sESC)

5.6.3 Battery State-of-Charge (SOC) LED Transitions

Battery State-of-Charge (SOC) LED transitions are based on voltage thresholds. When SOC percentage is available from an installed ReadyShunt or ReadyBMS accessory (see Battery State-of-Charge (SOC) Reporting in Section 4.2.7) the SOC LED transitions will be based on SOC percentage.

Factory Default Battery SOC LED Voltage Thresholds

SOC LEDs	Voltage Threshold
Green	battV > 13.3V
Green / Yellow	13.0V < battV <= 13.3V
Yellow	12.65V < battV <= 13.0V
Yellow / Red	battV <= 12.65V
Red	During LVD

Note that voltage threshold State-of-Charge LED displays are only approximate indications of battery charge state, and have variable accuracy during charging and discharging. In addition, the factory default SOC LED indication settings are not appropriate for all battery types and system designs. Therefore, it is recommended that the settings be custom programmed, if required, to better indicate actual SOC.

Suggested Battery SOC LED Voltage Threshold Custom Settings for Lead Acid Batteries - valid during bulk charging - see next page

SOC LEDs	Voltage Threshold
Green	battV > 13.3V
Green / Yellow	13.0V < battV <= 13.3V
Yellow	12.5V < battV <= 13.00V
Yellow / Red	battV <= 12.50V
Red	During LVD

NOTE: Lower settings can be used to better indicate SOC during periods of battery discharge.

Suggested Battery SOC LED Voltage Threshold Custom Settings for Lithium (LFP) Batteries:

SOC LEDs	Voltage Threshold
Green	battV > 13.4V
Green / Yellow	13.25V < battV <= 13.4V
Yellow	13.1V < battV <= 13.25V
Yellow / Red	battV <= 13.1V
Red	During LVD

Factory Default SOC LED SOC Percentages - for use with ReadyBMS or ReadyShunt accessory:

SOC LEDs	Condition
Green	SOC > 80%
Green / Yellow	60% < SOC <= 80%
Yellow	40% < SOC <= 60%
Yellow / Red	SOC <= 40%
Red	LVD or Low SOC Disconnect

5.6.4 Ethernet Jack Indications

In addition to the SOC LEDs, two (2) small LEDs can be found on the Ethernet RJ-45 jack inside the wiring box. These LEDs indicate the LAN/WAN network link and activity status as follows:

Condition	Green LED	Yellow LED
Network Connection OK	ON	OFF
Network Activity	ON	Blinking
Error	OFF	ON

5.7 Alarms and Faults

Alarms and faults are indicated with LEDs on the unit, and with brief descriptions in LiveView web interface. Alarms are generally informational (see Ready Block Alarms below), and faults cause interruption in operation.

5.7.1 Alarms

Battery Sense Out of Range / Disconnected (only alarm with LED indications)

Status LED: Flashing red. Battery status LEDs: R/Y - G/Y sequencing. A battery sense wire is

disconnected. Inspect the battery sense connections. This alarm is set when the voltage at the battery sense terminals differs by more than five volts from the voltage at the battery terminals.

Current Limit

The array power exceeds the rating of the controller. This alarm indicates that the GenStar MPPT is limiting battery current to the maximum current rating.

Heatsink Temperature Sensor Open / Shorted

The heatsink temperature sensor is damaged. Contact your Authorized Morningstar Dealer for service.

High Input Voltage Current Limit

The GenStar MPPT will limit the solar input current as the solar array Voc approaches the maximum input voltage rating. The array Voc should never exceed the 200 Volt maximum input voltage - see the array voltage de-rating graph in Appendix.

High Temperature Current Limit

The GenStar MPPT will limit the solar input current if the heatsink temperature exceeds safe limits. Solar charging current will be tapered back (to 0 Amps if needed) to reduce the heatsink temperature. The GenStar MPPT will operate with full-rated current up to +45°C (at full power) and may derate at higher ambient temperatures. Systems with higher array input voltages will have higher internal temperatures resulting in a greater amount of high temperature current-limiting above +45°C. Maximum charging current yield depends on many factors, including sufficient airflow, and good ventilation can greatly reduce the amount of de-rating. If the controller frequently reports this alarm condition, corrective action should be taken to provide better air flow, or to move the controller to a cooler location.

Load Short Circuit

Status LED: Flashing red. Battery status LEDs: R/G-Y sequencing. Fully protected against load wiring short-circuits. After two (2) automatic load reconnect attempts (10 seconds between each attempt) the GenStar MPPT will wait, and then automatically reconnect the load, once the short is cleared.

RTS Open

The Remote Temperature Sensor is not connected to the controller. Use of the RTS is recommended for proper battery charging.

Uncalibrated

The controller was not factory calibrated. Contact your Authorized Morningstar Dealer for service.

READYBLOCK ALARMS

A BMS, Shunt or Relay Block can trigger the following alarms on the host which will trigger a disconnection (shutdown) of the charge controller.

BMS Block Removed - if the host is configured to use a battery that requires BMS communication and a BMS block is not connected to the Ready Rail (BlockBus), this alarm will be present until a BMS block is connected.

BMS Lost Communication - if for any reason the ReadyBMS is present and communication with a battery is lost, this alarm will be present until communication is re-established.

BMS Sense Error - BMS sense voltage reading has diverged from expected value

BMS Sense Disconnect - BMS sense was connected, but has been disconnected

Shunt or Relay Block - if the host is configured in any way to use a ReadyShunt or ReadyRelay. and

one of those blocks is not connected to the Ready Rail (BlockBus), this alarm will be present until the required block is connected.

5.7.2 Faults

EEPROM Custom Settings Edit

Status LED: Flashing red. Battery status LEDs: R-Y-G sequencing. A value has been modified in custom settings memory. The controller will stop charging and indicate a fault condition. After all settings have been modified, the controller must be reset by removing and then restoring power to the controller. The new programmed settings will be used after the power reset.

Firmware Update Failure

The firmware update was not successfully programmed. The controller will not indicate the full power-up LED sequence of G-Y-R when power to the controller is reset. Instead, the controller will display green, and then stop on yellow. The yellow LED will continue to be lit and the controller will not complete start up or begin charging. Re-try the firmware update. The firmware must be successfully loaded before the controller will start up.

High Heatsink Temperature

Status LED: Flashing red. Battery status LEDs: R-Y sequencing. The heatsink temperature has exceeded safe limits and the load is disconnected. The load will automatically reconnect when the heatsink cools to a safe temperature.

High Solar Voltage Disconnect

Status LED: None. Battery Status LEDs: R-Y-G. If the solar input open-circuit voltage (Voc) exceeds the 185 Volt maximum rating, the array will remain disconnected until the Voc falls to 175V

Load High Voltage Disconnect (HVD) - disabled by default for lead-acid presets

Status LED: None. Battery status LEDs: R-G sequencing. This fault is set when battery voltage is above normal operating limits. The controller will disconnect the load output and set a Load High Voltage Disconnect fault. This fault is designed to protect sensitive loads from excessive voltage. Recovery occurs at HVD re-connect threshold, if programmed, and the fault will clear automatically.

Load Over-current

Status LED: Flashing red. Battery status LEDs: R/Y-G sequencing. If the load current exceeds the maximum load current rating, the GenStar MPPT will disconnect the load. The greater the overload the faster the load will be disconnected. A small overload could take a few minutes to disconnect. The GenStar MPPT will attempt to reconnect the load two (2) times. Each attempt is approximately 10 seconds apart. If the overload remains after two (2) attempts, the load will remain disconnected until power is removed and re-applied.

Load Short Circuit

State-of-charge LED sequence: R/G - Y (similar to load overcurrent is R/Y - G). The GenStar MPPT will attempt to reconnect the load two (2) times. Each attempt is approximately 10 seconds apart. If the overload remains after two (2) attempts, the load will remain disconnected until power is removed and re-applied.

Remote Temperature Sensor (RTS)

Status LED: Flashing red. Battery status LEDs: R/Y - G/Y sequencing. A bad RTS connection or a severed RTS wire has disconnected the temperature sensor during charging. See Tables 3.3 and 3.4 in Section 3 for RTS Start-up and Run-time operation and issues.

High Battery Voltage Disconnect (HVD)

Status LED: Flashing red. Battery status LEDs: R-G sequencing. This fault is set when battery voltage is above normal operating limits. The controller will disconnect the solar input and set a Solar High Voltage Disconnect fault. This fault is commonly caused by other charging sources in the system, charging the battery above the GenStar MPPT regulation voltage. Recovery occurs at HVD re-connect threshold, and the fault will clear automatically.

SOLID CHARGING STATUS LED with SELF-TEST (R-Y-G) SOC FAULTS

Verify that nothing has been miswired. If not, the error is likely critical. The table below lists a few common critical faults. See local meter display (Status Menu) for specific error. Contact an authorized Morningstar dealer for support.

Charging Status LED ¹	Fault	Battery SOC LEDs
Solid red	PV FET Short	R-Y-G sequencing
Solid red	Load FET Short	R-Y-G sequencing
Solid red	Load FET Open	R-Y-G sequencing
Solid red	Damaged heatsink temperature sensor	R-Y-G sequencing
Solid red	Software	R-Y-G sequencing

¹ Solid R Charging Status LED ON with heartbeat blink OFF every five seconds is a critical fault that generally requires service. See local meter display (Status Menu) for specific error.

STAND-ALONE CHARGING STATUS LED INDICATIONS

Charging Status LED	CONDITION
OFF (with heartbeat ON every 5 sESC)	Not charging
Green solid (with heartbeat OFF every 5 sESC)	Charging
Momentary flashing red, then solid red ¹	Charger fault ¹

¹ See unit meter display (refer to meter map for location) for specific error.

5.8 LiveView Menus

LiveView is Morningstar web pages served directly from the GenStar MPPT. The web pages closely coincide with the GenStar MPPT meter layout and functions. Many LiveView pages are organized

into cards, which are rectangular areas that group commands, settings, and other information. Cards can be rearranged or hidden to suit a user's application preferences.

5.9 Commands

Commands can be accessed in the main LiveView dashboard, or in the primary meter screen. Commands are used to control the functions in Sections 5.9.1 - 5.9.6 below. Also see LiveView Command screens for further details.

5.9.1 Toggle Load Terminal Output Commands

Load Output - force the load off. Useful for service/maintenance activities or ensuring the load does not run for a period of time.

LVD Override (15 min) - turn on the load when it is in Low Voltage Disconnect State for 15 minutes. After 15 minutes the load will turn back off and resume LVD state. The user can override LVD and unlimited number of times, but too many overrides will cause over-discharge and possible battery damage.

5.9.2 Counters Commands

Clear-reset counters using commands:

All Resettable Counters - resets the Resettable A-h and Resettable kW-h counter values to zero. Resettable counters are intended to track mostly in the short-term, for example, accumulations since a battery replacement, or a new load was added to a system.

All Total Counters - clears the Total A-h and Total kW-h counter values to zero. Total counters are intended to track long-term / lifetime accumulations of a system.

5.9.3 Toggle Battery Charger Command

Connect or disconnect charging functions using commands:

Manual Equalization - Manually start or stop an equalize charge on a lead-acid battery. This command is only functional for battery charging profiles with Equalization enabled

Battery Charger - Override normal operation and force the battery charger to a disconnected state. The GenStar MPPT will not charge the battery while the charger is in disconnected state.

5.9.4 System Commands

Activate System commands:

Reboot Control - Software resets the GenStar MPPT. All controller functions, including battery charging and power to the loads, will cease until the reboot is complete.

5.9.5 External Source Control (ESC) Commands

Control external source signal with commands:

- Enable External Source Control relay - available only in Custom ESC
- Disable External Source Control relay - available only in Custom ESC
- Manual External Source Control ENABLE-DISABLE command - available only in manual ESC, with ReadyRelay assigned to ESC Start-Stop
- E-Stop - de-energizes the ESC relay immediately. Available only with ReadyRelay assigned to ESC Start-Stop.

5.9.6 ReadyRelay Commands

ReadyRelay commands can be toggled ON-OFF when there are assigned-available ReadyRelays. Relays can also be scheduled for automatic operation.

Only a ReadyRelay that has been assigned as, "Command/Schedule", can be triggered with commands. To configure ReadyRelays, enter the installer access password 141 in main LiveView Screen and go to Installer Setup\Ready Blocks to configure Relay Block functions.

Installed Relay Blocks will be listed by positions 1-3 (maximum), and show Relay A and/or B. Position 1 is the first block on the left.

5.10 History

The History Page consists of Daily Records and Event Logging as seen in 5.10.1 and 5.10.2 below. The Event Logger provides real-time stamping of system events on all aspects of operation. Combined, the history features provide a full picture that allows users to assess performance and investigate operational issues.

5.10.1 Daily Records

Daily Records

Displays the following records for the current day, and generally back for a year in time - depending on how many daily variables are logged:

- Battery NET (A-h)
- Charging Timers (mins)
- Absorption
- Float
- Equalize
- Max. Battery Voltage (V)
- Min. Battery Voltage (V)
- Max. Battery Temperature (°C)
- Min. Battery Temperature (°C)
- Array Voltage max

- Charge kWhr
- Charge Ah
- Load 0 Ah
- Load 1 Ah
- Load 2 Ah
- Load 3 Ah
- Net battery system Ah
- Charge system kWhr
- Faults & Alarms
- Additional records are appended to this list, e.g., ReadyShunt counters

The GenStar can store a finite number of daily records internally. However, the data size of daily records will expand as data from ReadyBlocks and other accessories are added; this will reduce the maximum number of records that can be stored internally.

If an SD card is used for logging, the maximum number of records will vary depending on the capacity of the card.

5.10.2 Event Logging

All loggable variables are recorded, and can be filtered by event type, date range, specific date and some assignments within an Event Type. Event Types and variables may change depending on current firmware reporting parameters.

Event logging can be configured either in LiveView webpage or in local meter display.

Event Logging. A complete list of logged variables can be seen in local meter display or LiveView/History/Event Log

Loggable events are divided into *Event Types* (and examples for each type):

Battery

Issues (Errors) - Faults and alarms

Network - Time servers, LAN connections

ESC - ESC events

Command - DC load output disconnected

System

5.11 Setup

See Section 4 - Configuration

5.12 Firmware Updates

Updates are newer versions of GenStar MPPT firmware. Updating methods via serial PC connections to the GenStar MPPT:

- USB-C
- RS-232
- EIA-485

Firmware can also be updated via RJ-45 (Ethernet) connection using LiveView (see Ethernet/RJ-45 Firmware Update below).

GenStar MPPT firmware must first be downloaded from the Morningstar Website: **morningstarcorp.com**. The firmware file will download to your computer as ZIP folder and will need to be extracted for use. The procedure for extracting the compressed files will depend on the type of PC, e.g., Windows (and specific version), MAC or other. Once extracted, save the GenStar firmware file to an easily accessible location, e.g., desktop.

Serial Firmware Updates

For USB-C and RS-232 connections, the MS Load Firmware Utility must be installed (downloadable at **morningstarcorp.com**) on the PC, and there must be access to the new firmware (.msc) file. Start MSLoad™ and when prompted, choose the desired file.

Ethernet/RJ-45 Firmware Updates

CAUTION:

The controller may fail to properly reboot after a firmware update leaving the system offline and without power. Remote firmware updates via the internet are not recommended. Always reboot after a firmware update. Check the LiveView Update Screen box to automatically reboot after the update. The system will lose power during a reboot!

To update firmware via an RJ-45/Ethernet connection, first follow the instructions in Section 4.1.2 to set up a LiveView connection on a PC screen or mobile app - if available. Click on the, "Update", button on the dashboard, and then select and upload a new file.

5.12.1 Update via SD Card

 **WARNING: Risk of Explosion**

When loading a system image configuration from an SD Card, ensure that the destination device has the same system voltage, battery profile, and RTS; otherwise, there is a potential risk of system damage or bodily injury.

After uploading new firmware (.msc) file from PC to SD Card:

- 1) Insert SD card into the side slot to the left of the GenStar MPPT meter
- 2) Navigate to Setup\Firmware\Load Firmware
- 3) Select the desired firmware file, and confirm loading from the SD Card
- 4) A progress bar will indicate loading of firmware update into the GenStar MPPT memory. This will take several minutes.
- 5) When complete, select Okay to update the GenStar MPPT firmware

5.13 Inspection and Maintenance

Table 5-4 below lists the recommended maintenance schedule to keep the GenStar MPPT performing optimally.

 **WARNING: Risk Of Electrical Shock**

No power or accessory terminals are electrically isolated from dc input, and may be

energized with hazardous solar voltage. Under certain fault conditions, battery could become over-charged. Test between all terminals and ground before touching.

 **WARNING: Shock Hazard**
Disconnect all power sources to the controller before removing the wiring box cover. Never remove the cover when voltage exists on the GenStar MPPT power connections.

Schedule	Maintenance Items
2 weeks after installation	Re-tighten power terminal connections to specified torque values.
3 months after installation	Re-tighten power terminal connections to specified torque values.
Monthly or After Each Equalization	Inspect the battery bank. Look for cracked or bulging cases, and corroded terminals. For wet cell (flooded type) batteries, make sure the water level is correct. Wet cell water levels should be checked monthly or according to the manufacturer's recommendations.
Annually	Clean the heatsink fins with a clean, dry rag. Inspect all wiring for damage or fraying. Inspect for nesting insects. Re-tighten all wiring terminal connections to specified torque values. Inspect the system earth grounding for all components. Verify all grounding conductors are appropriately secured to earth ground.

Table 5-5. Maintenance Schedule

6.0 NETWORKING AND COMMUNICATIONS

6.1 Introduction

 **NOTE:**
MS-CAN (CANbus) functionality is not available with initial release.

The GenStar MPPT provides several communication options. The GenStar MPPT uses a proprietary protocol for the MS-CAN network and the non-proprietary open standard MODBUS™ and MODBUS TCP/IP™ protocols for RS-232, EIA-485, and Ethernet networks. Additionally, HTTP and NTP are supported for web page and real-time clock support.

Hardware and third party software that supports the MODBUS™ protocol can be used to communicate with a GenStar MPPT.

Multiple communication ports can be used simultaneously - **note that the RS-232 and EIA-485 connections share hardware, and therefore cannot be used simultaneously.** An example of multiple port use: GenStar MPPT may be connected to a MS-CAN network for on-site system metering, connected to the Internet for remote monitoring, and connected to an EIA-485 network to bridge data from other controllers in the system to an Internet connection.

Table 6-1 below provides a summary of supported features for each communication interface.

	MS-CAN	USB-C	RS-232	EIA-485	Ethernet
Connect a GS-MPPT to other Morningstar devices	•				
Connect multiple GS-MPPT together in a network	•			•	•
Update firmware		•	•		•
Modbus communications			•	•	•
LiveView web app: View data, change settings, update firmware					•

Table 6-1. Communications summary

6.2 Morningstar MS-CAN (MS-CAN functionality is not available with this release.)

Morningstar's proprietary MS-CAN allows communication between compatible Morningstar products. Use MS-CAN to:

- Display net system data for multiple GenStar MPPT systems
- Share battery temperature information across multiple GenStar MPPT controllers
- Synchronize charging stages across multiple GenStar MPPT controllers
- Aggregate data and centrally control Morningstar load devices like SureSine inverters

6.3 Serial RS-232

The serial port connection on the GenStar MPPT is a standard 9-pin isolated RS-232 port. See Figure 2-3 (#9) for the port location. The GenStar MPPT communicates through the serial port via the open standard MODBUS™ protocol.

Connect the GenStar MPPT to the serial port for:

- Modbus RTU communications
- Controller firmware updates with MSLoad™ firmware utility. **LiveView Update page is recommended for faster uploads.**



NOTE:

The RS-232 and EIA-485 ports share hardware. Both ports cannot be used simultaneously.

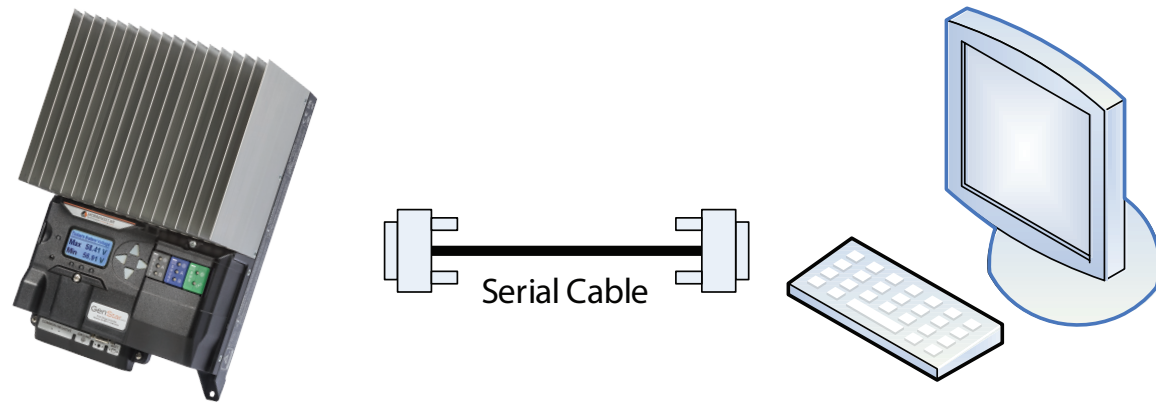

Figure 6-1. A serial connection between a PC and the GenStar MPPT

Default Serial Port Settings:

- 9600 Baud rate
- 8 data bits
- 1 or 2 stop bits
- no parity

6.4 Modbus and ModbusIP via EIA-485

EIA-485 is a networking standard for serial communication between multiple devices on a bus. The GenStar MPPT communicates over an EIA-485 network via the open standard MODBUS™ protocol. Use EIA-485 networking to:

- Facilitate Modbus communications between GenStar MPPT controllers and other Modbus devices
- Bridge an Ethernet connection through a GenStar MPPT to an EIA-485 network

An EIA-485 Bus System allows monitoring of multiple GenStar units using the GenStar MPPT EIA-485 terminals to set up a 3-wire bus to connect GenStar units. The unit used for monitoring must have, "Bridging", enabled in either its local meter or in LiveView.

EIA-485 WIRING

The EIA-485 port has three (3) connections: GND, Data A, Data B. Data A & B are differentially driven data lines that carry the network data. The GenStar MPPT supplies isolated power to the EIA-485 network, eliminating the need for an external bus power source in many cases.

Connections:



WARNING: Shock Hazard

Before wiring, verify that all system breakers and disconnect switches are in the OPEN/DISCONNECTED position, and that all fuses are removed from their holders.

- 1) From left to right, connect GND, Data A, Data B wires to the GenStar EIA-485 terminals.
- 2) Connect GND, Data A and Data B wires (with the same order and orientation as on the GenStar EIA-485 terminals) to a desired bus-connected controller, e.g., another GenStar.
- 3) If a desired bus-connected (EIA-485 compatible) controller is not a GenStar, a voltage supply will need to be provided to the bus at the connected controller.

Networks requiring power can be supplied by an external source. The source voltage must be between 8-16 Vdc. For 12 Volt systems, the network can be powered directly from the system battery. For 24, 36, and 48 Volt systems, use a DC-DC converter.



CAUTION: Equipment Damage

Tapping power off of individual batteries in a series string of batteries can cause a voltage imbalance. Damage to the batteries may result. Always use a DC-DC converter to power the EIA-485 network if the nominal system voltage is greater than 12 volts.



NOTE:

The RS-232 and EIA-485 ports share hardware. Both ports cannot be used simultaneously.

For more information on EIA-485 networking, refer to the, "Morningstar Communications Document", on the Morningstar website at:

www.morningstarcorp.com

6.5 Ethernet



CAUTION: Risk of Tampering

The GS-MPPT does not feature built-in network security. It is the responsibility of the user or network administrator to place the GS-MPPT behind a network firewall to prevent unauthorized access.

The Ethernet port supports HTTP, MODBUS TCP/IP™, and NTP protocols to provide a fully web-enabled interface between the GenStar MPPT and a LAN/WAN network or the internet. Use the Ethernet connection to:

- View the LiveView web app - see Section 4.1.2 - from a PC or mobile device on the same LAN/WAN
- Communicate with the GenStar MPPT via Modbus TCP/IP

This section provides a summary of the feature. For detailed information about Ethernet connectivity and networking, refer to the, "Morningstar Communications Document", on the Morningstar website at:

www.morningstarcorp.com

6.6 Simple Network Management Protocol (SNMP) - v2c Supported

SNMP is an IP-based communications protocol. Some uses and advantages include:

- favors a centralized system network management
- allows simultaneous mass device polling and reporting
- allows coil reads and writes
- supports an unlimited number of pollable devices
- low system latency, i.e., minimal system processing resources are used
- low-level security **Community Strings** are included and verified with each query

NOTE: Firmware may not be updated using SNMP writes

A **MIB File** - available at morningstarcorp.com - serves as a directory of system information available for retrieval from the GenStar MPPT using an SNMP **GET** Command, or from the MIB itself. The GET Command is described below. An **Object Identifier (OID)** is a component of a MIB File that contains either a single, or a collection of variables, e.g., solar specific values which can be queried by, or configured from, an **SNMP Browser** on a **Network Management System (NMS)/Manager** monitoring computer. SNMP commands can retrieve, manage, modify, and parse GenStar MPPT data. The GenStar unit acts as an **SNMP Agent**.

There is various third-party, licensed NMS software available for using SNMP to monitor the GenStar MPPT. NMS MIB files, along with a MIB importer and SNMP browser applications, may be required to set up and run SNMP communications.

An industry-standard GenStar MPPT MIB File with OIDs and scaling factors is contained in a zip file that can be downloaded at https://www.morningstarcorp.com/support/library/?_document_product=23774&_document_type=technical-document. The following commands are supported:

SET

The SNMP SET operation is used by the management applications and applets to modify the value of the managed object. If needed for an application, one or more MIB variables can be modified by using the SNMP SET operation.

SNMP WRITE PROCESS

1) Write the new value for a given setting:

SNMP SET SETTING_OID NEW_VALUE

2) Write the new value to EEPROM by writing "TRUE" to the EEPROM session apply coil:

SNMP SET EEPROM_SESSION_APPLY_OID TRUE [Writing "FALSE" to this coil will cancel the write operation, and then require repeating Step 1.]

3) Perform a soft re-boot (which loads the newly written value(s) from EEPROM) by writing "TRUE" to the reset coil:

SNMP SET RESET_OID TRUE

GET

A Manager-to-Agent request to retrieve the value of a variable or list of variables on a specific OID. Retrieval of the specified variable values is an atomic operation by the Agent, i.e., it will not be completed without all requested values returned.

GETNEXT

A Manager-to-Agent request to discover available variables and their values. Method used by SNMP manager to work through an ordered list of OIDs according to the standard MIB hierarchy. Returns a response with variable binding for the next variable in the MIB.

GET BULK

A sequence of GetNext requests, allowing a large segment of the MIB hierarchy to be queried by the SNMP manager from a managed device.

RESPONSE

Used by the SNMP agent to deliver requested information. Also acts as an acknowledgment.

DEFAULT PORT ASSIGNMENT

Port 161 - SNMP Agent Receiving Port

33333 is Morningstar's registered IANA enterprise number

1.3.6.1.4.1 is the standard address to the "enterprises" node, so

Morningstar Enterprise OID = 1.3.6.1.4.1.33333

6.6.1 SNMP Troubleshooting

Confirm data inconsistency with other MS monitoring platforms, e.g., MODBUS TCP, HTTP-LiveView, and then ensure the following:

- MIB files are current and all reference MIBs are uploaded simultaneously, i.e., MORNINGSTAR.mib, and GenStar MPPT.mib
- each OID references the appropriate data value type listed in the MIB file
- Community String names are properly configured (they will reset after a factory reboot). Write Community should be set to, "private". Read Community should be set to, "public".
- network monitoring software is set to SNMP v2c
- correct IP address and Root OID are used for SNMPWalk

6.7 Network Information

Connect to the GenStar MPPT via an Ethernet network (LAN/WAN) or connect the controller directly to a PC using an Ethernet cable. Use CAT-5 or CAT-5e twisted pair Ethernet cables with RJ-45 connectors. A network diagram for both scenarios is shown in Figure 6-2 below.

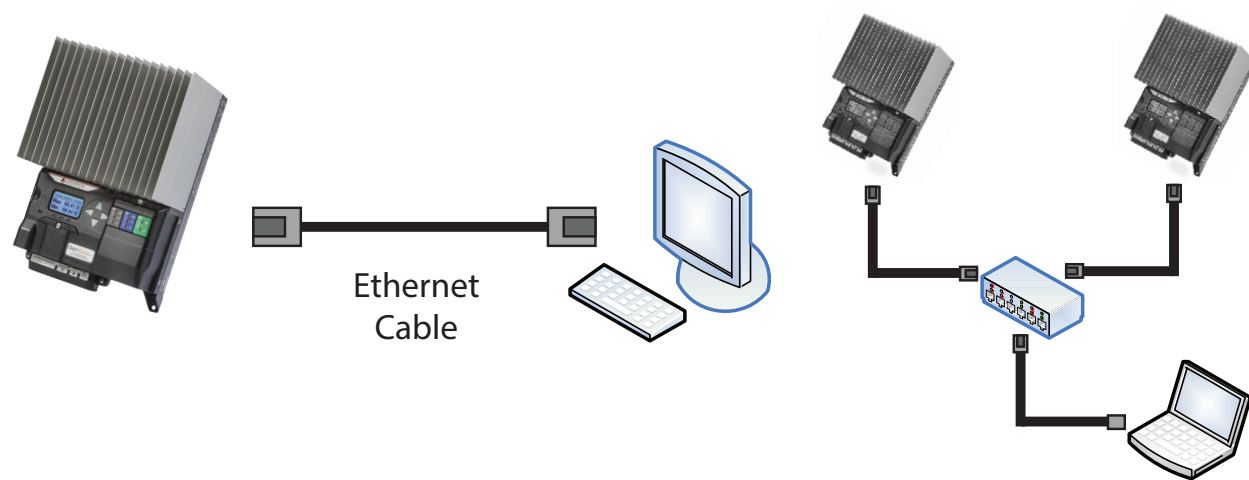

Figure 6-2. Ethernet network diagrams

Factory Default Network Settings

DHCP	Enabled
LiveView Web Address	http://gsmpppt + serial number ¹
IP	192.168.1.253 (if DHCP is not enabled)
Subnet Mask	255.255.255.0
Gateway	192.168.1.1
Primary DNS Server	169.254.1.1
MODBUS TCP/IP™ Port	502

¹ The LiveView web address is unique to each controller. If the GenStar MPPT serial number is 09501234, then the GenStar MPPT's LiveView address is: http://gsmpppt09501234. For reference, the LiveView web address is printed on the serial label on the side of the unit.

The controller's MAC Address is located on the serial label on the side of the controller. Two (2) LEDs on the Ethernet jack indicate link and activity status.

Condition	Green LED	Yellow LED
Network Connection OK	ON	OFF
Network Activity	ON	Blinking
Error	OFF	ON

6.8 Accessing LiveView Web Pages

Connect the GenStar MPPT controller to the network using an Ethernet cable. Wait five to ten minutes for the controller to connect to the network. Open a web browser on a PC or mobile device on the network. Enter the LiveView web address in the address bar of the web browser. LiveView webpages are context-aware and will properly format to the device's screen size.

Also see Configuration Section 4.1.2 for further details.

7.0 TROUBLESHOOTING



WARNING: RISK OF ELECTRICAL SHOCK.

NO POWER OR ACCESSORY TERMINALS ARE ELECTRICALLY ISOLATED FROM DC INPUT, AND MAY BE ENERGIZED WITH HAZARDOUS SOLAR VOLTAGE. UNDER CERTAIN FAULT CONDITIONS, BATTERY COULD BECOME OVER-CHARGED. TEST BETWEEN ALL TERMINALS AND GROUND BEFORE TOUCHING.



WARNING: Shock Hazard

A means of disconnecting all power supply poles must be provided. These disconnects must be incorporated in the fixed wiring. Open all power source disconnects before removing controller wiring cover, or accessing wiring.

7.1 LED Fault Indications

Battery Over-current

Error status LED: Flashing red. Battery status LEDs: R/Y-G sequencing. While rare, if battery current exceeds approximately 130% of the controller's output current rating, this fault can occur. The fault is generally related to fast, large battery voltage transients (connecting a very heavy or capacitive load like an inverter) that are faster than the controller can regulate, and it shuts off to protect the circuitry. The controller will automatically re-start in 10 seconds.

Battery Reverse Polarity

No LED indication, the unit is not powered. No damage to the controller will result. Correct the miswire to resume normal operation.

Custom Settings Edit

Error status LED: Flashing red. Battery status LEDs: R-Y-G sequencing. A value has been modified in custom settings memory. The controller will stop charging and indicate a fault condition. After all settings have been modified, the controller must be reset by removing and then restoring power to the controller. The new programmed settings will be used after the power reset.

Firmware Update Failure

The firmware update was not successfully programmed. The controller will not indicate the full power-up LED sequence of G-Y-R when power to the controller is reset. Instead, the controller will display green, and then stop on yellow. The yellow LED will continue to be lit and the controller will not complete start up or begin charging.

Re-try the firmware update. The firmware must be successfully loaded before the controller will start up.

High Heatsink Temperature

Error status LED: Flashing red. Battery status LEDs: R-Y sequencing. The heatsink temperature has exceeded safe limits and the load is disconnected. The load will automatically reconnect when the heatsink cools to a safe temperature.

High Solar Voltage Disconnect

Status LED: None. Battery Status LEDs: R-Y-G. If the solar input open-circuit voltage (Voc) exceeds the 185 Volt maximum rating, the array will remain disconnected until the Voc falls to 175V

High Load Voltage Disconnect (HVD) - disabled by default

Error status LED: None. Battery status LEDs: R-G sequencing. This fault is set when battery voltage is above normal operating limits. The controller will disconnect the load output and set a Load High Voltage Disconnect fault. This fault is designed to protect sensitive loads from excessive voltage. Recovery occurs at HVD re-connect threshold, if programmed, and the fault will clear automatically.

Load Over-current

Error Status LED: Flashing red. Battery status LEDs: R/Y-G sequencing. If the load current exceeds the maximum load current rating, the GenStar MPPT will disconnect the load. The greater the overload the faster the load will be disconnected. A small overload could take a few minutes to disconnect. The GenStar MPPT will attempt to reconnect the load two (2) times. Each attempt is approximately 10 seconds apart. If the overload remains after two (2) attempts, the load will remain disconnected until power is removed and re-applied.

Load Short Circuit

Error status LED: Flashing red. Battery status LEDs: R/G-Y sequencing. Fully protected against load wiring short-circuits. After two (2) automatic load reconnect attempts (10 seconds between each attempt) the GenStar MPPT will wait, and then automatically reconnect the load, once the short is cleared.

Remote Temperature Sensor (RTS)

Error status LED: Flashing red. Battery status LEDs: R/Y - G/Y sequencing. A bad RTS connection or a severed RTS wire has disconnected the temperature sensor during charging. See Tables 3.5 and 3.6 - in Section 3 - for details on start-up and runtime behavior.

High Battery Voltage Disconnect (HVD)

Error status LED: Flashing red. Battery status LEDs: R-G sequencing. This fault is set when battery voltage is above normal operating limits. The controller will disconnect the solar input and set a Battery High Voltage Disconnect fault. This fault is commonly caused by other charging sources in the system, charging the battery above the GenStar MPPT regulation voltage. Recovery occurs at HVD re-connect threshold, and the fault will clear automatically.

7.2 Battery Charging and Performance Issues

Problem:

No LED indications, controller does not appear to be powered

Solution:

With a multi-meter, check the voltage at the battery terminals on the GenStar MPPT. Battery voltage must be 9 vdc or greater. If the voltage on the battery terminals of the controller is between 9 and 72 Vdc, and no LEDs are lit, contact your authorized Morningstar dealer for service. If no voltage is measured, check wiring connections, fuses, and breakers.

Problem:

The GenStar MPPT is not charging the battery.

Solution:

Check the three (3) battery SOC LEDs. If they are flashing in a sequence, to determine the cause, see Sections 5.7 and 6.1 of this manual. Meter and LiveView will display active faults and alarms.

If the LED indications are normal, check the fuses, breakers, and wiring connections in the power source wiring. With a multi-meter, check the array voltage directly at the GenStar MPPT solar input terminals. Input voltage must be greater than battery voltage before charging will begin.

Problem:

Controller makes buzzing and humming noises.

Solution:

No action is required. This is expected due to magnetic resonance and circuit switching.

If troubleshooting does not correct the problem, please refer to Morningstar's Warranty Claim Procedure in Section 8.

8.0 WARRANTY & POLICIES



WARRANTY

LIMITED WARRANTY - Morningstar Solar Charge Controllers and Inverters

Integrated Series products, SureSine Family (Gen 2) inverters and other Morningstar *Professional Series™* products, except the SureSine™-300 Classic (Gen 1) inverter, are warrantied to be free from defects in materials and workmanship for a period of FIVE (5) years from the date of shipment to the original end user. Warranty on replaced units, or field-replaced components, will be limited only to the duration of the original product coverage.

Morningstar *Essentials Series™* products, and SureSine™-300 Classic (Gen 1) inverter, are warrantied to be free from defects in materials and workmanship for a period of TWO (2) years from the date of shipment to the original end user. Warranty on replaced units, or field-replaced components, will be limited only to the duration of the original product coverage.

Morningstar will, at its option, repair or replace any such defective units.

CLAIM PROCEDURE:

Before requesting warranty service, check the operator's manual, including any troubleshooting section, to verify product failure. To begin the warranty replacement process, contact your authorized Morningstar distributor or dealer for assistance with troubleshooting and, if necessary, obtaining an RMA number.

An RMA number must be issued by Morningstar prior to return of any unit(s) under this warranty. Required RMA information:

- (A) purchase location - business or company name - and date
- (B) full model and serial numbers (SN is 8-digits on unit bar label)
- (C) failure behavior, including LED indications
- (D) array configuration, panel Pmax, Voc, Vmp, Isc, and nominal battery voltage - these specifications are needed to receive assistance.
- (E) multi-meter available (for field troubleshooting)

After the dealer is contacted, and is not able to assist with warranty claim, contact Morningstar Technical support at support@morningstarcorp.com. Please provide proof of date and place of purchase, and all details listed in preceding paragraph.

WARRANTY EXCLUSIONS AND LIMITATIONS:

This warranty does not apply under the following conditions:

- Damage by accident, negligence, abuse or improper use
- PV or load currents exceeding the ratings of the product
- Unauthorized product modification or attempted repair
- Damage occurring during shipment
- Damage resulting from acts of nature such as lightning, weather extremes, or infestation

(Cont.)

THE WARRANTY AND REMEDIES SET FORTH ABOVE ARE EXCLUSIVE AND IN LIEU OF ALL OTHERS, EXPRESS OR IMPLIED. MORNINGSTAR SPECIFICALLY DISCLAIMS ANY AND ALL IMPLIED WARRANTIES, INCLUDING, WITHOUT LIMITATION, WARRANTIES OF MERCHANTABILITY AND FITNESS FOR A PARTICULAR PURPOSE. No Morningstar distributor, agent or employee is authorized to make any modification or extension to this warranty.

MORNINGSTAR IS NOT RESPONSIBLE FOR INCIDENTAL OR CONSEQUENTIAL DAMAGES OF ANY KIND, INCLUDING BUT NOT LIMITED TO LOST PROFITS, DOWN-TIME, GOODWILL OR DAMAGE TO EQUIPMENT OR PROPERTY.

Morningstar Corporation
8 Pheasant Run, Newtown, PA 18940 USA
(215) 321-4457

www.morningstarcorp.com
support@morningstarcorp.com

R20-4/23

9.0 TECHNICAL SPECIFICATIONS

	GS-MPPT-60M-200V	GS-MPPT-80M-200V	GS-MPPT-100M-200V
Electrical:			
Maximum Battery Charge Current	60 Amps	80 Amps	100 Amps
Maximum Input Voltage (Voc)	ALL: 200 Volts		
MPPT Operating Voltage Range	ALL: > battery voltage + 1 Volt; < 180 Volts		
Max. Input Current (Imp/Isc)	56/60 Amps	75/80 Amps	94/100 Amps
Nominal Operating Voltage	ALL: 12-24-48 VDC		
Battery Voltage Range	ALL: 9-72V (charging); 10-72V (load); Power OFF < 8V		
Maximum Load Current	30 Amps	30 Amps	30 Amps
Maximum Self-consumption	< 2.4 Watts (12/24V); < 3.2 Watts (48V)		
Grounding Leg	ALL: Negative (pos. ground compatible with array float)		
Real Time Clock (RTC)	ALL: With coin cell (CR-2032)		
Peak Efficiency	ALL: 99%		
Transient Surge Protection	ALL: 4500 Watts/port		
Nominal Maximum Output Power (Watts)	12, 24, 48 Volts 800, 1600, 3200	12, 24, 48 Volts 1064, 2128, 4256	12, 24, 48 Volts 1330, 2660, 5320
Mechanical:			
Dimensions (cm/in)	38.8/15.3 (L) x 8.7/22.2 (W) x 5.9/15.1 (H)		
Weight (lb/kg)	14.625 / 6.63	15.625 / 7.09	16.4375 / 7.46
Wire Size Range:			
Battery and PV input terminals	10 - 53.5 mm ² / #8 - 1/0 AWG		
Load terminals	2.5 - 13.3 mm ² / #14 - 6 AWG (EXCEPT fine-stranded #6)		
Equip. grounding terminals	2.5 - 33.6 mm ² / #14 - 2 AWG		
Battery voltage sense and RTS	0.25 - 1.0 mm ² / #24 - 16 AWG		
Maximum torque:			
Battery and PV input terminals	100 in-lb / 11.3 N-m		
Load terminals	35 in-lb / 3.9 N-m		
Equip. grounding terminals	50 in-lb / 5.65 N-m		
Battery voltage sense and RTS	5 in-lb / 0.565 N-m		
Enclosure	IP20, Type 1		
Battery Charging:			
4-stage Charging:	Bulk, Absorption, Float, Equalization		
Temperature compensation			
Coefficient:	-30mV/12 volt/°C (shared for Lead-acid presets; disabled by default for Lithium presets)		
Temperature-compensated set-points:	Absorption, Float, Equalize, HVD, HVDR (solar)		
Current Compensation:	See Section 5.2.2, Table 5-4 for presets		
Compensated set-points	LVD		
Solar HVD-HVR:			
Solar High Voltage Disconnect		Lead-acid (Volts) Highest set-point in preset charging profile [+ 0.5V (@ 25°C)]	Lithium (Volts) 14.5
Solar High Voltage Reconnect		13.8	13.6

GENSTAR MPPT - all models	
Communication-Interfaces:	
SD Card	Yes
USB-C for data	Yes
RS-232 Port	Yes
EIA-485 Port	Yes
Ethernet/RJ-45 Port	Yes
Controller Area Network (CAN)	Yes
Local Display:	
Digital Meter:	
Resolution	128 x 64
Viewing Area	70mm x 40mm
Display Color	
Backlight:	Blue on white
Operating Temperature	-20°C to +60°C
Storage Temperature	-50°C to +80°C
Environmental:	
Maximum Operating Altitude	3000 meters
Ambient Temperature Range:	Full-power from -30°C to +45°C (then current de-rated proportionally to +60°C)
Storage Temperature	-50°C to +80°C
Humidity	100% n.c.
Tropicalization	Conformally coated PCBs; Marine-rated terminals
Protections:	
Reverse night current	Battery removal protection
Power-up against any active faults	Low temp foldback
Reverse polarity - array	High temp. foldback
Solar short-circuit	Solar high voltage foldback
Solar overload (current limit)	Load over-current
High heatsink temperature - current de-rating	Heatsink temperature Limit
High heatsink temperature - load disconnect	High voltage (solar, battery, load)
Load short-circuit	Short-circuit

Efficiency

GenStar MPPT Efficiency vs Output Power - 12 Volt Charging, 100A - battery @12.8V

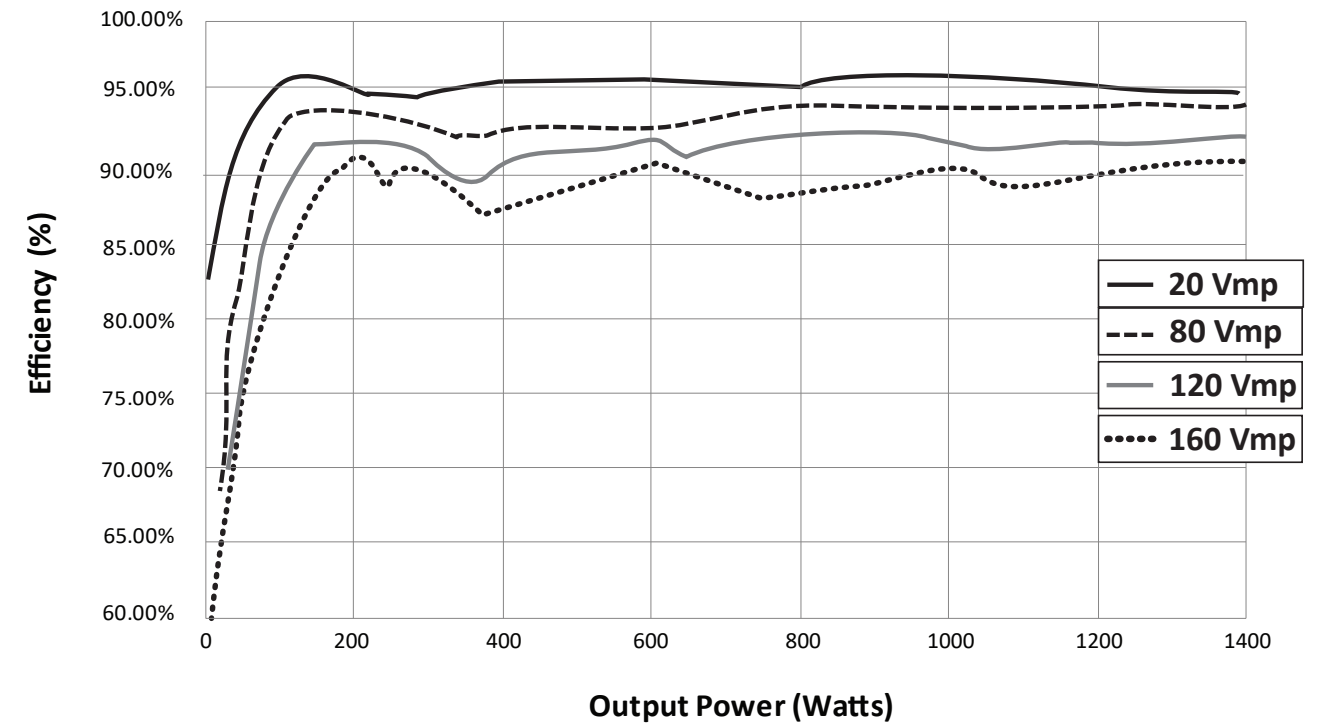

GenStar MPPT Efficiency vs Output Power - 24 Volt Charging, 100A - battery @25.6V

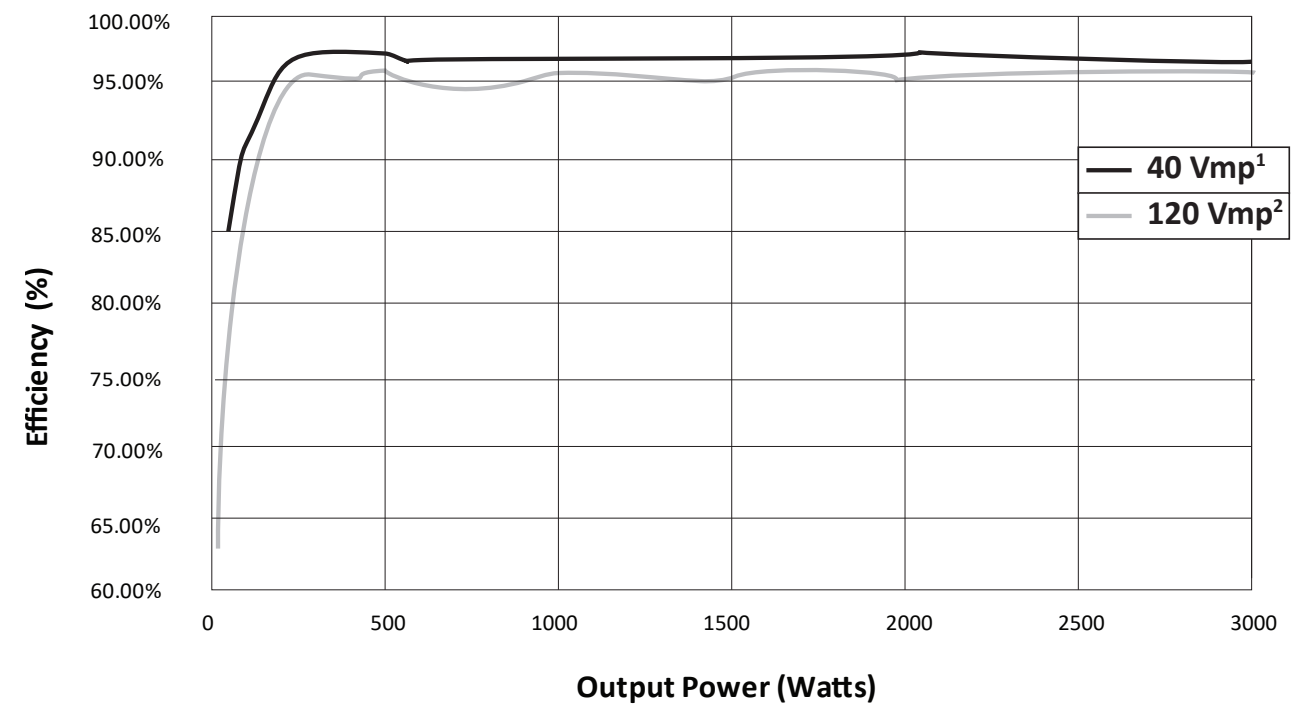

NOTES:

¹ 80 Vmp curve is very close to 40 Vmp, but most power points are slightly less efficient.
² 160 Vmp curve is very close to 120 Vmp, but most power points are slightly less efficient.

GenStar MPPT Efficiency vs Output Power - 48 Volt Charging, 100A - Battery @51.2V

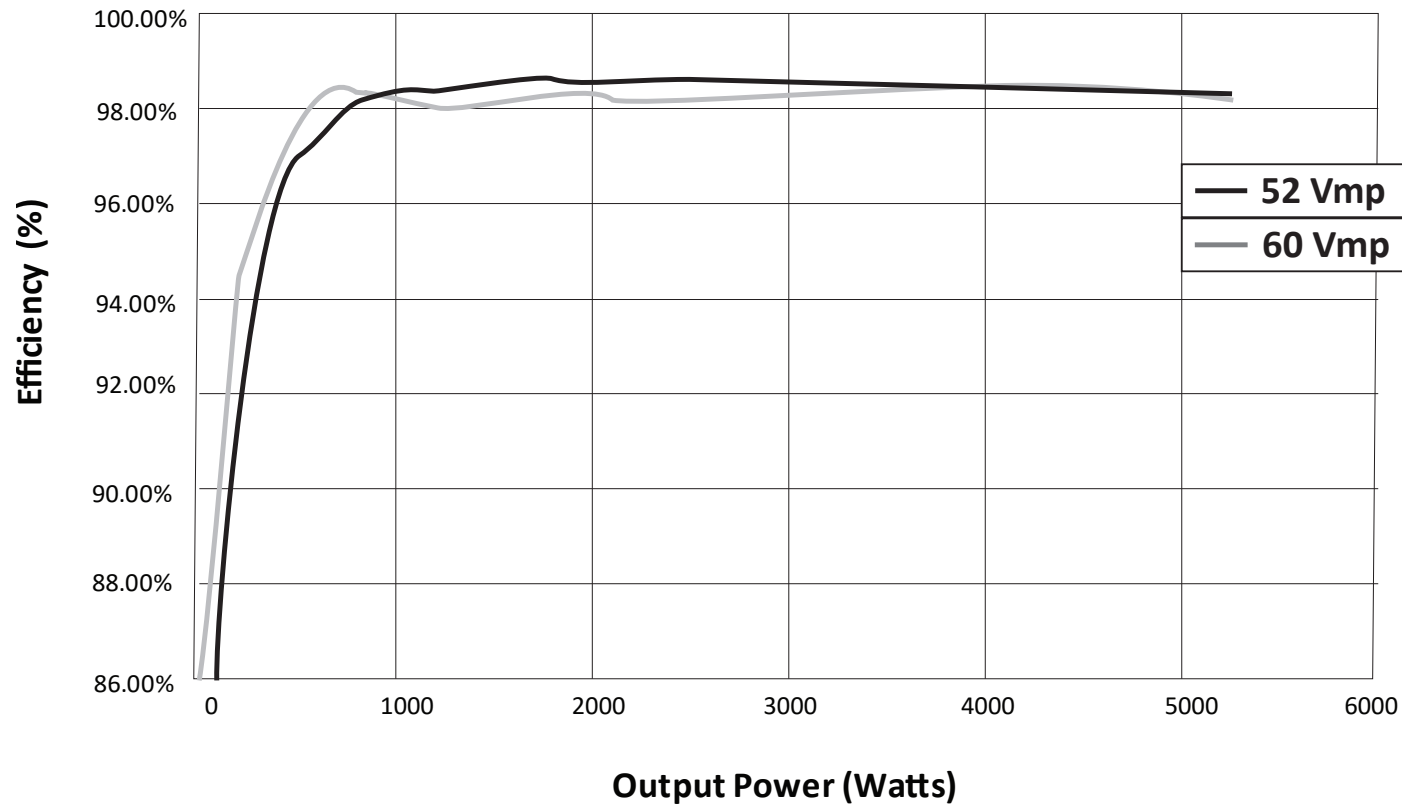

Efficiency vs Output Power 80A Unit at 12V Nominal Voltage (12.8Vbatt)

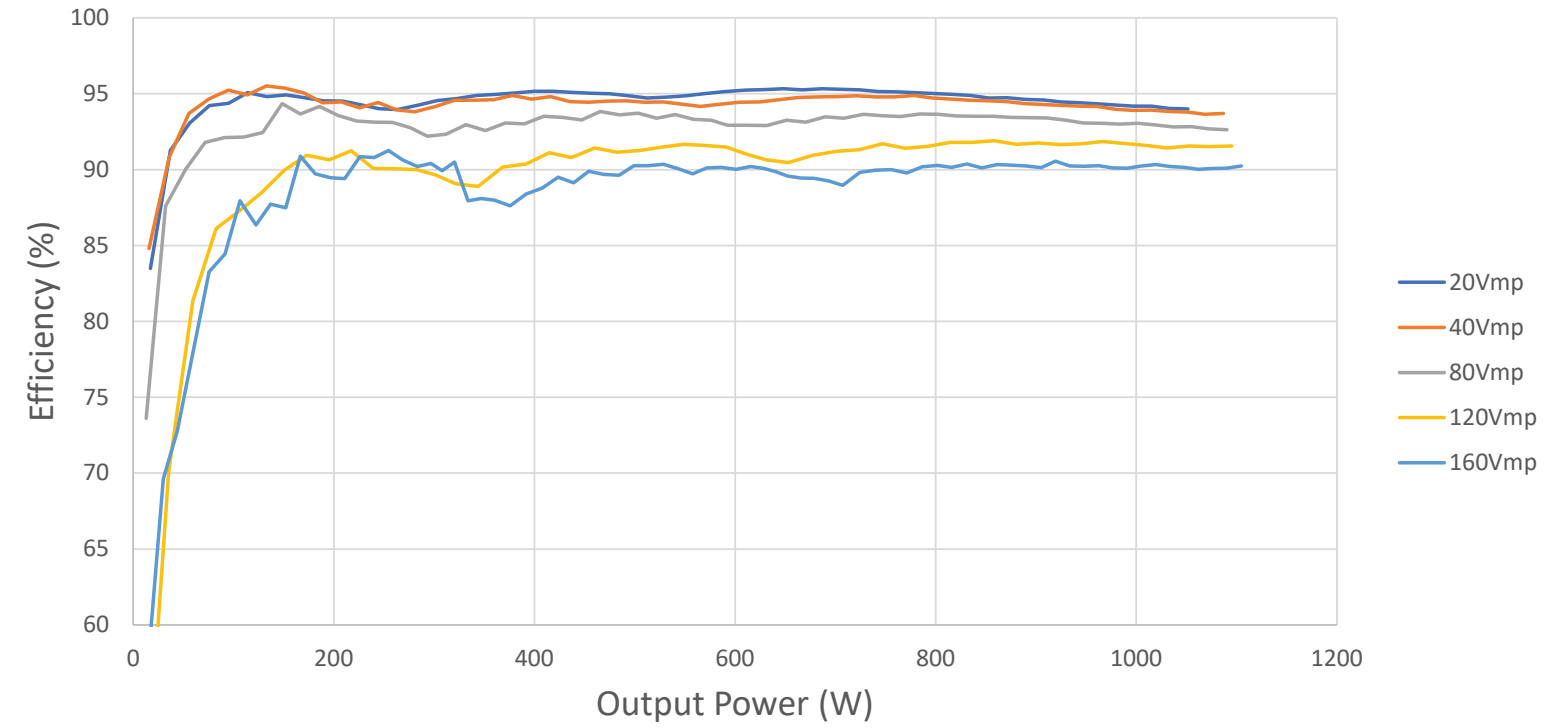

GenStar MPPT Efficiency vs Output Power - 48 Volt Charging, 100A - battery @51.2V

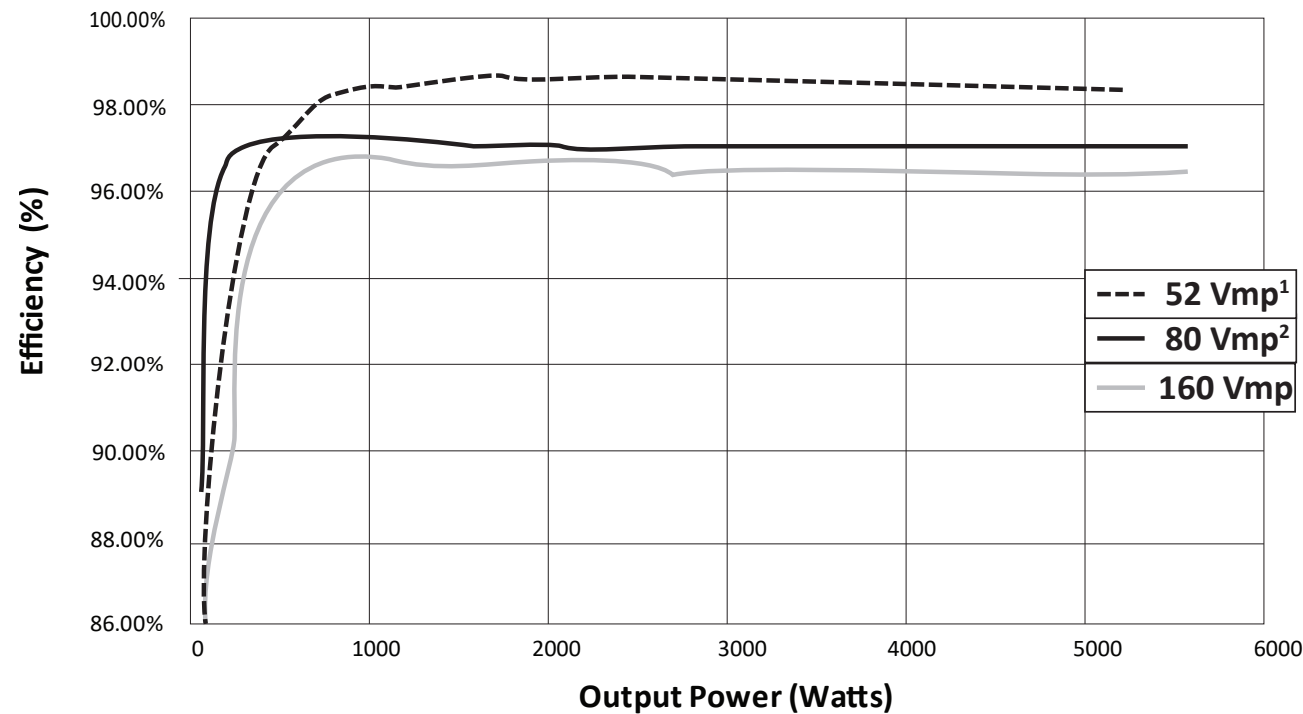

Efficiency vs Output Power 80A Unit at 48V Nominal Voltage (51.2Vbatt)

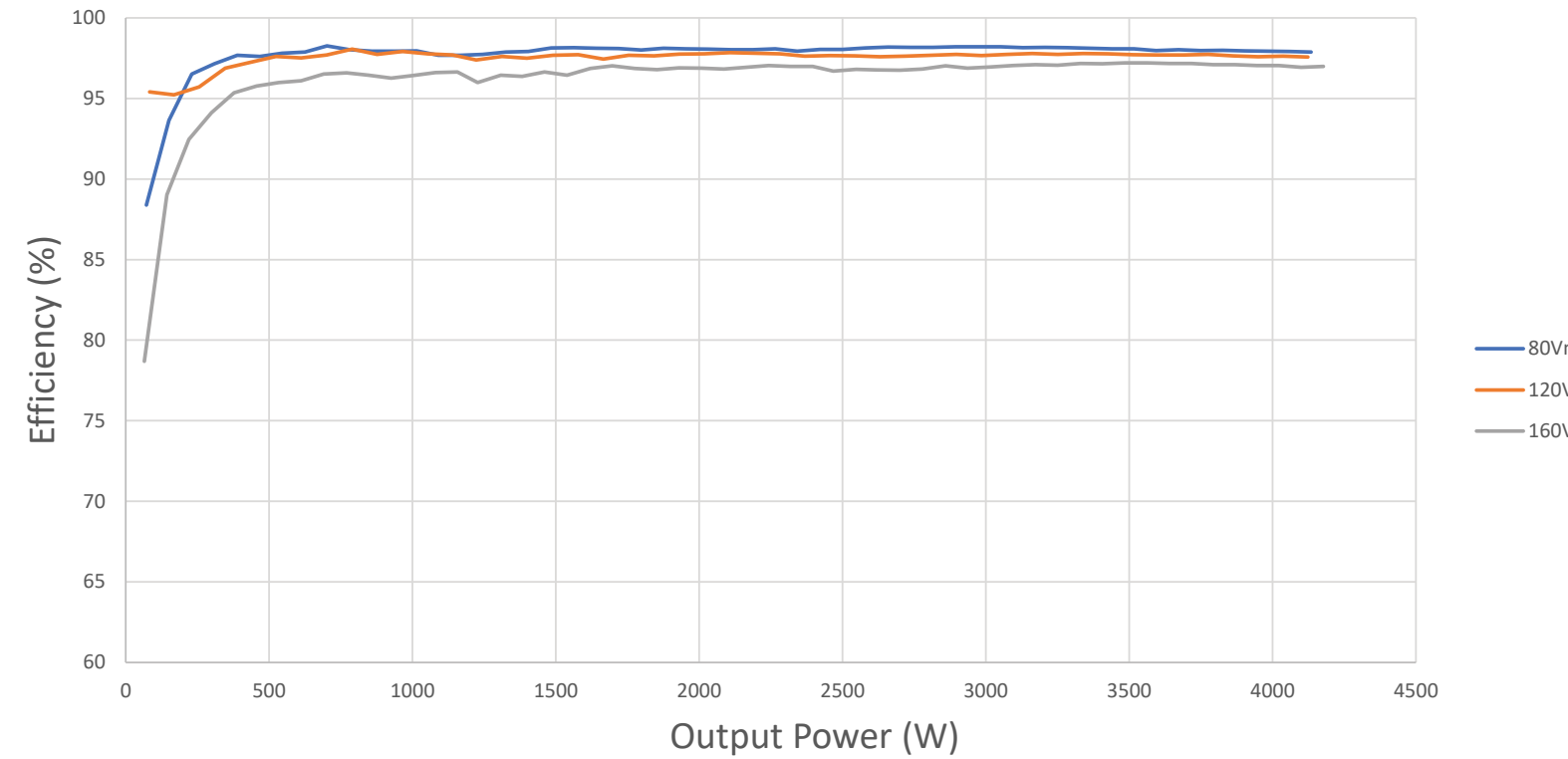

NOTES:

- ¹ 60 Vmp curve is very close to 52 Vmp, but most power points are slightly less efficient.
- ² 120 Vmp curve is very close to 80 Vmp, but most power points are slightly less efficient.

Efficiency vs Output Power
80A Unit at 24V Nominal Voltage (25.6Vbatt)

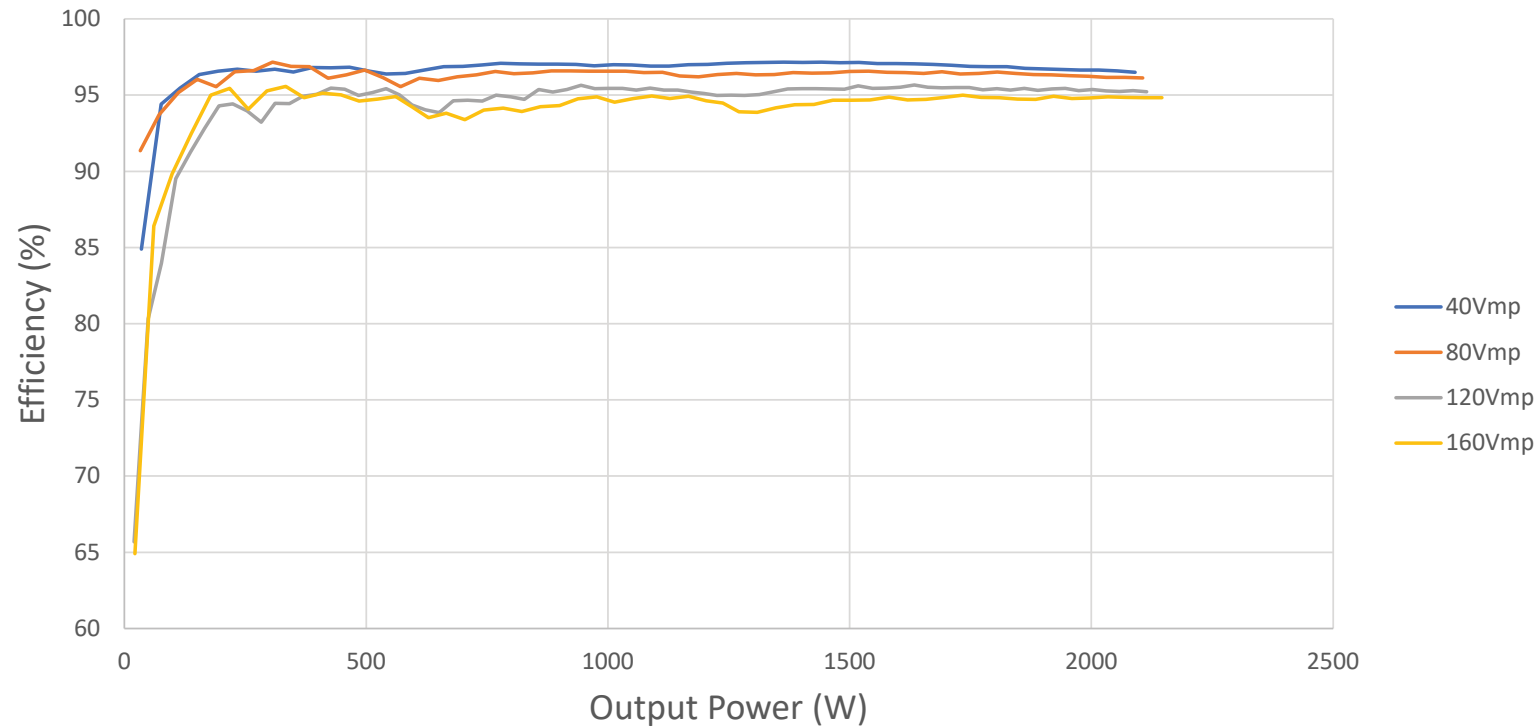

Efficiency vs Output Power
60A Unit at 12V Nominal Voltage (12.8Vbatt)

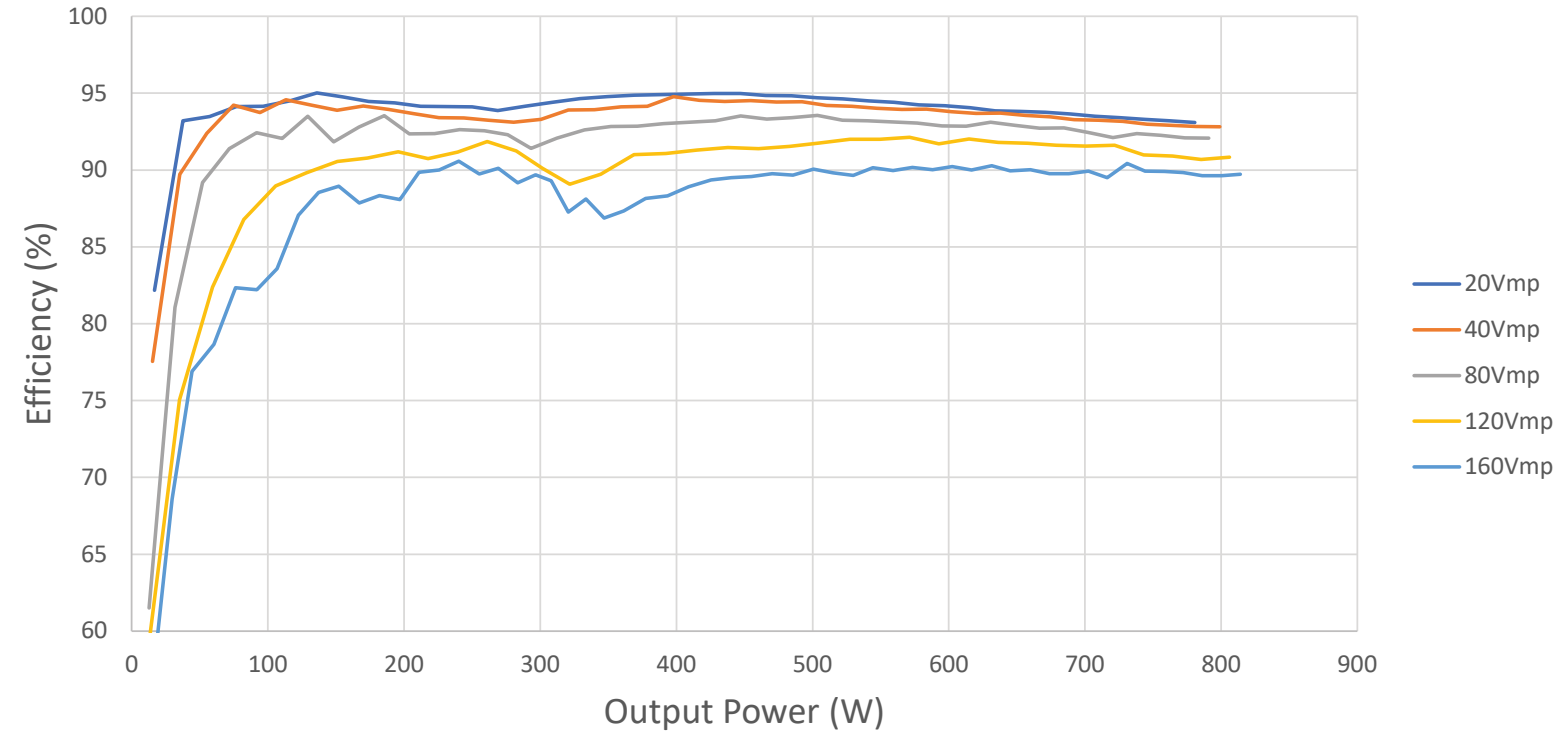

Efficiency vs Output Power
60A Unit at 24V Nominal Voltage (25.6Vbatt)

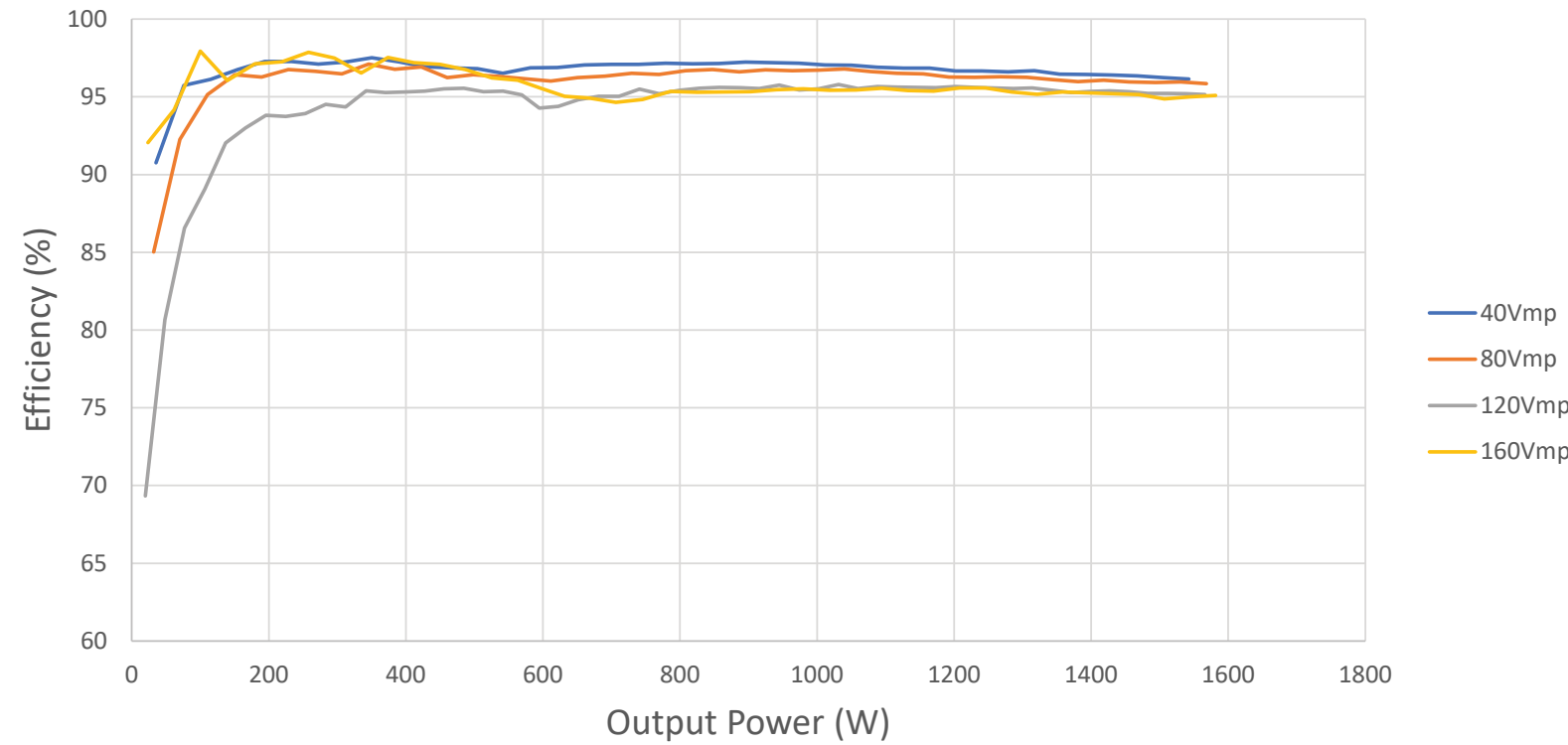

APPENDIX - Wire Sizing Information

Wire sizing requirements are based on the ampacity (current carrying capacity) of conductors. The NEC includes Ampacity Tables which are used to determine the ampacity for a given wire size as indicated in Section 310.15.

GenStar power terminals are rated for 75°C. When wires with a 90°C temperature rating are used with terminals that have a 75°C temperature rating, wire ampacity at 75°C must be used.

Wire ampacity requirements for the battery, PV array and load circuits are:

Controller battery wire ampacity must be greater than or equal to 125% of maximum continuous current (battery current rating of the controller)

PV array wire ampacity must meet both of the following requirements:

Must be greater than or equal to 156% of PV Array Isc without correction and adjustment factors

Must be greater than or equal to 125% of PV Array Isc with correction and adjustment factors

Load wire ampacity must be greater than or equal to the **load breaker current rating.**

NEC Section 240.4(D) requires a maximum breaker or fuse rating for smaller wire sizes as follows:

14 AWG Copper: 15 Amps OCPD and wire ampacity

12 AWG Copper: 20 Amps OCPD and wire ampacity

10 AWG Copper: 30 Amps OCPD and wire ampacity

Therefore, where load circuit-breakers or fuses are larger than indicated above, a larger wire must be used.

Correction and adjustment factors may also be required to account for the following:

- Maximum ambient temperature
- temperatures at different parts of the circuit (rooftops or engine rooms for example)
- wire terminal temperature ratings
- multi-conductor cables
- conduit fill and other factors

Celsius to Fahrenheit Conversions

°Celsius	°Fahrenheit
30	86
35	95
40	104
45	113

Table A-1. Celsius to Fahrenheit Conversions

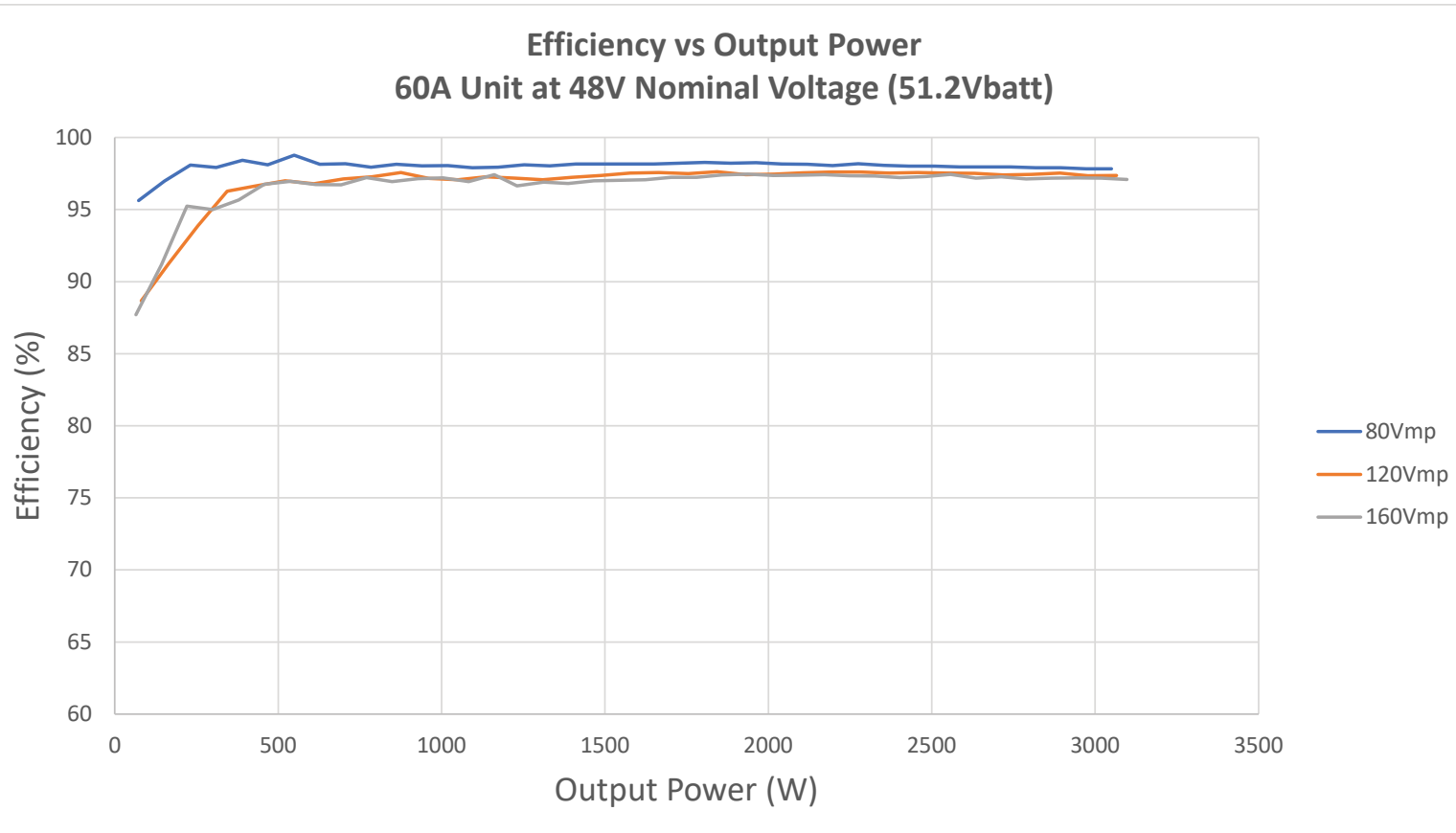

Minimum Battery Wire Sizing - 75°C rated copper

MODEL	Wire Size in a raceway, cable, or earth ¹		Wire Size in free air ²		Metric Wire Size ³ (mm ²)
	@30°C	30°-45°C	@30°C	30°-45°C	
GS-MPPT-60	#4 AWG	3 AWG > 40°C	#6 AWG	#6 AWG	16 - 25
GS-MPPT-80	#3 AWG	2 AWG > 30°C 1 AWG > 40°C	#4 AWG	#4 AWG	25 - 35
GS-MPPT-100	#1 AWG	1/0 > 30°C 2/0 > 40°C	#4 AWG	3 AWG > 30°C 2 AWG > 40°C	35 - 50

NOTES:

1 Per NEC 2021 [see NEC Table 310.15(b)(16)], ampacity for not more than three current-carrying conductors in a raceway, cable, or earth (buried)

2 Per NEC 2021 [see NEC Table 310.15(b)(17)], ampacity for conductors in free air

3 Estimated. See local code requirements for metric cable sizing

Table A-2. Minimum DC battery wire sizes for 75°C copper

Minimum Output/Load Wire Sizing (based on breaker or fuse sizes)

Breaker or fuse Rating	@30°C	Metric Wire Size (mm ²)
15 Amps	#14 AWG	2.5
20 Amps	#12 AWG	4
25 Amps	#10 AWG	6
30 Amps	#10 AWG	6
40 Amps	#8 AWG	10

Table A-3. DC load output wire sizes

2% Voltage Drop Chart for 75°C or 90°C Stranded Copper Wire

Maximum 1-way distance (feet), 12 Volt system - multiply values by (2) for 24 Volt, and by (4) for 48V, system

Wire Size (AWG)	100A	90A	80A	70A	60A	55A	50A	45A	40A	35A	30A	25A	20A	15A
4/0 ¹	23.5	26.1	29.4	33.6	39.2	42.8	47.0	52.3	58.8	67.2	78.4	94.1	117.6	156.8
3/0 ¹	18.7	20.7	23.3	26.7	31.1	33.9	37.3	41.5	46.7	53.3	62.2	74.7	93.3	124.5
2/0 ¹	14.8	16.4	18.5	21.1	24.6	26.9	29.6	32.9	37.0	42.3	49.3	59.2	73.9	98.6
1/0	11.7	13.0	14.7	16.7	19.5	21.3	23.4	26.0	29.3	33.5	39.1	46.9	58.6	78.1
#1	9.3	10.3	11.6	13.3	15.5	16.9	18.6	20.6	23.2	26.5	31.0	37.1	46.4	61.9
#2	7.4	8.2	9.2	10.5	12.3	13.4	14.7	16.4	18.4	21.1	24.6	29.5	36.9	49.1
#3	5.8	6.5	7.3	8.3	9.7	10.6	11.7	13.0	14.6	16.7	19.5	23.3	29.2	38.9
#4	4.6	5.2	5.8	6.6	7.7	8.4	9.3	10.3	11.6	13.3	15.5	18.6	23.2	31.0
#6			3.6	4.2	4.9	5.3	5.8	6.5	7.3	8.3	9.7	11.6	14.6	19.4
#8					3.1	3.3	3.7	4.1	4.6	5.3	6.1	7.4	9.2	12.3
#10									2.9	3.3	3.8	4.6	5.8	7.7
#12												2.9	3.6	4.8
#14													2.3	3.0

¹Wires sizes larger than 1/0 AWG must be terminated at a splicer block located external to the GenStar MPPT. Use 1/0 AWG or smaller wire to connect to the GenStar MPPT to the splicer block.

Table A-4. Maximum 1-way wire distance for 12 Volt systems, stranded copper, 2% voltage drop

Maximum 1-way distance (meters), 12 Volt system - multiply values by (2) for 24 Volt, and by (4) for 48V, system

Wire Size (mm ²)	100A	90A	80A	70A	60A	55A	50A	45A	40A	35A	30A	25A	20A	15A
120 ¹	7.6	8.5	9.6	10.9	12.7	13.9	15.3	17.0	19.1	21.8	25.5	30.6	38.2	51.0
95 ¹	6.1	6.7	7.6	8.7	10.1	11.0	12.1	13.5	15.2	17.4	20.2	24.3	30.4	40.5
70 ¹	4.4	4.9	5.5	6.3	7.3	8.0	8.8	9.8	11.0	12.6	14.7	17.6	22.0	29.4
50	3.1	3.4	3.8	4.4	5.1	5.5	6.1	6.8	7.6	8.7	10.2	12.2	15.3	20.3
35	2.3	2.5	2.8	3.2	3.8	4.1	4.5	5.0	5.6	6.4	7.5	9.0	11.3	15.0
25	1.6	1.8	2.0	2.3	2.7	3.0	3.3	3.6	4.1	4.6	5.4	6.5	8.1	10.8
16				1.5	1.7	1.9	2.1	2.3	2.6	2.9	3.4	4.1	5.2	6.9
10							1.3	1.4	1.6	1.8	2.2	2.6	3.2	4.3
6											1.3	1.5	1.9	2.6
4												1.0	1.3	1.7
2.5													0.8	1.1

¹Wires sizes larger than 50 mm² must be terminated at a splicer block located external to the GenStar MPPT. Use 50 mm² or smaller wire to connect to the GenStar MPPT to the splicer block.

Table A-5. Maximum 1-way wire distance for 12 Volt systems, stranded copper, 2% voltage drop



Registration, Evaluation and Authorization of Chemicals

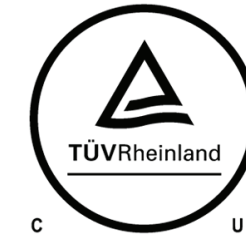

FOR CURRENT DETAILED CERTIFICATION LISTINGS, REFER TO:

<https://www.morningstarcorp.com/support/library>

Under, "Type", choose, "Declaration of Conformity (DOC)", to view a list of product DOCs.

GenStar MPPT™
Morningstar Corporation

MODBUS™ and MODBUS TCP/IP™ are trademarks of Modbus IDA.

©2023 Morningstar Corporation. All rights reserved.